

## Ferrofluids: Properties and Applications

C. Scherer\* and A. M. Figueiredo Neto\*\*

\*Instituto de Física, Universidade Federal do Rio Grande do Sul, 90570-100, Porto Alegre, RS, Brazil

\*\*Instituto de Física, Universidade de São Paulo, Caixa Postal 66318, 05315-970, São Paulo, SP, Brazil

Received on 28 July, 2005

Magnetic fluids may be classified as ferrofluids (FF), which are colloidal suspensions of very fine ( $\sim 10$  nm) magnetic particles, and magnetorheological fluids, which are suspensions of larger, usually non-stable, magnetic particles. We review the general classification and the main properties of FF, some theoretical models and a few applications. We consider the stability of a FF in terms of various forces and torques on the magnetic particles. We discuss thermodiffusion, which is an important phenomenon in FF, and which gives rise to the Soret effect. We also consider the rotational dynamics of the magnetic moments of the particles. A large portion of this review is dedicated to applications of FF, including a few of the many technological applications. Among the uses of a FF in the study of materials, we have selected the doping of liquid crystals. Among the very promising uses in Medicine, we discuss drug targeting, hyperthermia, cell separation, and contrast in magnetic resonance imaging. We also make some comments on directions for future research on the properties of ferrofluids.

### I. MAGNETIC COLLOIDS

A magnetic colloid, also known as a *ferrofluid* (FF), is a colloidal suspension of single-domain magnetic particles, with typical dimensions of about 10 nm, dispersed in a liquid carrier [1–3]. The liquid carrier can be polar or nonpolar. Since the nineteen sixties, when these materials were initially synthesized, their technological applications did not stop to increase.

Ferrofluids are different from the usual *magnetorheological fluids* (MRF) used for dampers, brakes and clutches, formed by micron sized particles dispersed in oil. In MRF the application of a magnetic field causes an enormous increase of the viscosity, so that, for strong enough fields, they may behave like a solid. On the other hand, a FF keeps its fluidity even if subjected to strong magnetic fields ( $\sim 10$  kG).

Ferrofluids are optically isotropic but, in the presence of an external magnetic field, exhibit induced birefringence [4]. Wetting of particular substrates can also induce birefringence in thin FF layers [5].

In order to avoid agglomeration, the magnetic particles have to be coated with a shell of an appropriate material. According to the coating, the FF's are classified into two main groups: surfacted (SFF), if the coating is a surfactant molecule, and ionic (IFF), if it is an electric shell.

There are essentially two methods to prepare these nanoparticles, by size reduction [1] and chemical precipitation [6]. In size reduction, magnetic powder of micron size is mixed with a solvent and a dispersant in a ball mill in order to grind for a period of several weeks. Chemical precipitation is probably the most used method to prepare magnetic nanoparticles nowadays. Different procedures have been developed to achieve this goal. In general, these procedures start with a mixture of  $\text{FeCl}_2$  and  $\text{FeCl}_3$  and water. Co-precipitation occurs with the addition of ammonium hydroxide, and then the system is subjected to different procedures to peptization, magnetic separation, filtration and finally dilution.

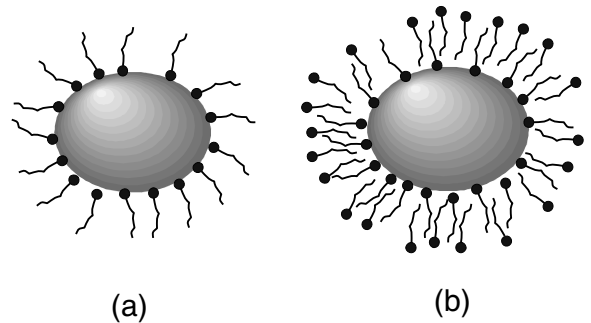

FIG. 1: Sketch of surfacted ferrofluid grains: a) single-layered grains; b) double-layered grains.

#### A. Surfacted ferrofluid

Surfacted ferrofluids are formed by magnetic particles (usually magnetite,  $\text{Fe}_3\text{O}_4$ ) coated with surfactant agents (amphiphilic molecules, as oleic acid and aerosol sodium di-2 ethylhexyl-sulfosuccinate) in order to prevent their aggregation. Steric repulsion between particles acts as a physical barrier [7] that keeps grains in the solution and stabilizes the colloid. If the particles are dispersed in a nonpolar medium, as oil, one layer of surfactant is needed to form an external hydrophobic layer. The polar head of the surfactant is attached to the surface of the particles and the carbonic chain is in contact with the fluid carrier. On the other hand, if the particles are dispersed in a polar medium, as water, a double surfactation of the particles is needed to form a hydrophilic layer around them. The polar heads of surfactant molecules can be cationic, anionic or nonionic. In Fig. 1 the sketches of an oil-based (Fig. 1a) and water-based (Fig. 1b) ferrofluid grains are presented.

Surfacted ferrofluids are widely used in technological devices, being commercially available [8][9].

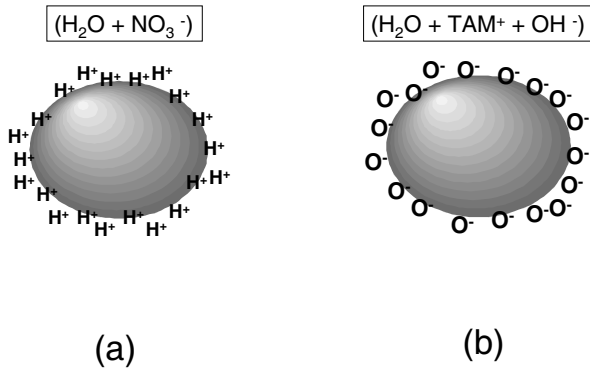

FIG. 2: Sketch of ionic ferrofluid grains. The counterions and the water molecules are also indicated: a) acid ferrofluid grain; b) alkaline ferrofluid grain, TAM<sup>+</sup>OH<sup>-</sup> is the tetramethylammonium hydroxide.

### B. Ionic ferrofluids

In ionic ferrofluids [10, 11], nanoparticles are electrically charged to keep the colloidal system stable. Magnetic particles (usually maghemite,  $\gamma$ -Fe<sub>2</sub>O<sub>3</sub>, and different ferrites,  $M$ Fe<sub>2</sub>O<sub>4</sub>, where  $M = \text{Mn, Co, Zn, Cu, Ni}$ ) are obtained through a chemical precipitation method, and an acid-alkaline reaction between particles and the bulk keeps the surface of them electrically charged [12, 13]. Usually, the liquid carrier is water, and the pH of the solution can vary from about 2 to 12, depending on the sign of the surface charge of the particles. Acid IFF ( $pH < 7$ ) have positively charged particles, and alkaline IFF ( $pH > 7$ ) have negatively charged particles. The surface charge density of the particles, typically of the order of  $10 \mu\text{C}/\text{cm}^2$  [14], is a function of the solution's pH. The *Point of Zero Charge* (PZC) is defined as the value of the pH at which the particles are not electrically charged (i.e., the ferrofluid precipitates). In Fig. 2 the sketches of an acid (Fig. 2a) and alkaline (Fig. 2b) ferrofluid grains are presented. Ionic citrated or tartrated maghemite ferrofluids have both characteristics (steric and electrostatic repulsion) to prevent aggregation of the particles. In the case of citrated ferrofluids, particles are coated with small chain molecules, as COOH-CH<sub>2</sub>-COH-COOH-CH<sub>2</sub>-COOH. In the presence of water, these attached molecules ionize. Besides the steric repulsion, there is also an electrostatic interaction.

Magnetic particles display an almost spherical geometry, with a non-uniform shape distribution [15]. The distribution  $P(D)$  of diameters  $D$ , is usually given by a log-normal function [16, 17],

$$P(D) = \frac{1}{D\sigma\sqrt{2\pi}} \exp\left(-\frac{\ln^2(D/D_o)}{2\sigma^2}\right), \quad (1)$$

where  $D_o$  and  $\sigma$  are the median diameter and standard deviation of  $\ln D$ , respectively.

The crystalline structure of the particles corresponds to the mineral *spinel*, MgAl<sub>2</sub>O<sub>4</sub>, in which divalent ions (i.e., Mn<sup>2+</sup>

and Co<sup>2+</sup>) replace ions of Mg, and ions of Fe<sup>3+</sup> replace ions of Al<sup>3+</sup> [18]. In this structure, the *bcc* primitive unit cell has 32 oxygen atoms, with 64 and 32 interstices of tetrahedral and octahedral symmetries, respectively. In direct spinel structures, ions  $M$  and Fe<sup>2+</sup> occupy 1/8 and 1/2 of the tetrahedral and octahedral sites, respectively. In inverse spinel structures, ions  $M$  occupy part of the octahedral sites and ions Fe<sup>2+</sup> occupy the rest of the octahedral and the tetrahedral sites. Globally, the nanocrystal is ferrimagnetic; the typical lattice parameter of maghemite, Co and Ni ferrites, is  $\sim 0.83 \text{ nm}$ . At saturation, the magnetization of maghemite, Co and Ni ferrites, is given by  $m_s = 400, 400$  and  $270 \text{ kA/m}$ , respectively. The magnetic moment of a grain ranges from  $\sim 10^3 \mu_B$  to  $10^5 \mu_B$ , where  $\mu_B$  is the Bohr magneton [19].

### C. Stability of the colloid

The stability of the magnetic colloid depends on the thermal contribution and on the balance between attractive (van der Waals and dipole-dipole) and repulsive (steric and electrostatic) interactions. The typical particle numerical density in a magnetic colloid is  $\sim 10^{23} \text{ m}^{-3}$ . To evaluate the typical particle diameter ( $D$ ) to avoid magnetic agglomeration we compare the thermal energy with the dipole-dipole pair energy [3] and get:

$$D \lesssim \left(\frac{72 k_B T}{\pi \mu_o M^2}\right)^{1/3}, \quad (2)$$

where  $k_B$ ,  $T$ ,  $\mu_o$  and  $M$  are the Boltzmann's constant, the absolute temperature, the permeability of free space and the intensity of magnetization. Plugging typical values in Eq. 2 one has  $D \lesssim 10 \text{ nm}$ .

#### 1. Attractive interactions

There are basically two main attractive interactions between magnetic particles in a ferrofluid, the van der Waals-London and the dipole-dipole interactions.

The van der Waals-London interaction,  $U_{Aw}$ , between two spherical particles of diameter  $D$ , separated by a distance  $r$ , is written as [20]:

$$U_{Aw} = -\frac{A}{6} \left[ \frac{2}{\alpha^2 - 4} + \frac{2}{\alpha^2} + \ln\left(\frac{\alpha^2 - 4}{\alpha^2}\right) \right], \quad (3)$$

where  $\alpha = 2r/D$  and  $A$  is the Hamaker constant ( $\sim 10^{-19} \text{ J}$  for ferrite particles [13]). This is a short-range interaction and the attractive force increases with the particles size.

The interaction energy between two magnetic dipoles,  $\mu_1$  and  $\mu_2$ , separated by a distance  $r$ , is given by:

$$U_{Ad} = \frac{\mu_o}{4\pi r^3} \left[ \mu_1 \cdot \mu_2 - 3 \left( \mu_1 \cdot \frac{\mathbf{r}}{r} \right) \left( \mu_2 \cdot \frac{\mathbf{r}}{r} \right) \right], \quad (4)$$

where  $\mathbf{r}$  is the relative position of the particles. In the ionic water-based ferrofluid MnFe<sub>2</sub>O<sub>4</sub>, with  $D_o = 10.7 \text{ nm}$ , the magnetic moment of a grain is about  $10^{-19} \text{ Am}^2/\text{grain}$  (or  $10^{-16}$  in CGS units).

## 2. Repulsive interactions

In ionic ferrofluids, long-range electrostatic interactions between charged particles give rise to repulsive interactions, which guarantee colloidal stability. On the other hand, in surfactant ferrofluids, there are steric repulsion forces, of short-range nature.

Let us discuss in more details the case of IFF. As the bulk of this material is electrically neutral, there are counter-ions in the bulk of the suspension in order to compensate the surface charged particles. These counter-ions are driven to the surface of the particles, but are also subjected to electrostatic repulsion. The calculation of the electrostatic repulsion between particles has to take into account this complex distribution of counter-ions. In the double-layer model [21], there is a first layer of counter-ions, called Stern layer, some angstroms thick, which involves the particle, and a second diffuse layer. These layers are separated by a Helmholtz plane. The diffuse layer is characterized by a Debye length,  $l_D \equiv \kappa^{-1}$ , which is defined as the distance, from the Helmholtz plane, at which the electrostatic potential is 37% smaller than the value at the plane. The interaction between two electrically charged spherical particles of diameter  $D$ , separated by a distance  $r$ , is written as [21]:

$$U_R = \frac{D\pi\sigma^2}{\varepsilon_0\varepsilon_r\kappa^2} \exp[-\kappa(r-D)], \quad (5)$$

where  $\sigma = \varepsilon_0\varepsilon_r\kappa\psi_0$  is the surface charge density,  $\varepsilon = \varepsilon_0\varepsilon_r$  is the electric permittivity of the fluid carrier, and  $\psi_0$  is the surface potential of the charged particle at the Helmholtz plane (with typical value  $\psi_0 < 50$  mV).

The case of steric repulsion is treated in some detail in Ref. [3]. It turns out that this repulsion energy is linearly dependent on temperature. For spherical particles of diameter  $D$ , with a surfactant shell of thickness  $\delta$  and density  $\xi$  molecules per  $nm^2$ , at temperature  $T$  one gets:

$$\frac{U_{st}}{k_B T} = \frac{\pi D^2 \xi}{2} \left[ 2 - \frac{l+2}{t} \ln \left( \frac{1+t}{1+l/2} \right) - \frac{l}{t} \right] \quad (6)$$

where  $l = 2s/D$ ,  $s = r - D$  is the separation between surfaces and  $t = 2\delta/D$ .

## 3. Total interaction potential

The behavior of the total interaction potential  $U_T$  between particles, as a function of the interparticle distance  $r$ , is sketched in Fig. 3. At short interparticle distances,  $r/D = 1$ , there is a cutoff due to hard-sphere interactions (not shown in the figure). Increasing  $r$ , but still  $r/D \approx 1$ , the force is dominated by van der Waals attraction. Increasing further, it becomes dominated by the shielded Coulomb repulsion, in the case of IFF, or by the steric repulsion, in the case of SFF. For larger values of  $r$  (see Fig. 4), there appears a secondary minimum. The most stable ferrofluids are designed so that the

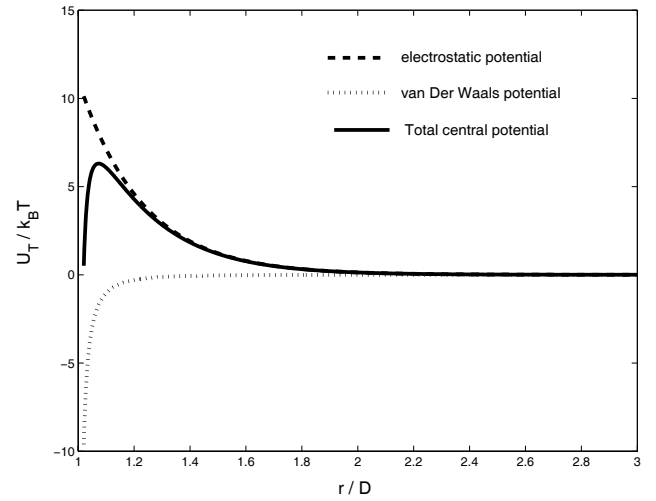

FIG. 3: Interparticle central potential, in units of  $k_B T$  for room temperature.

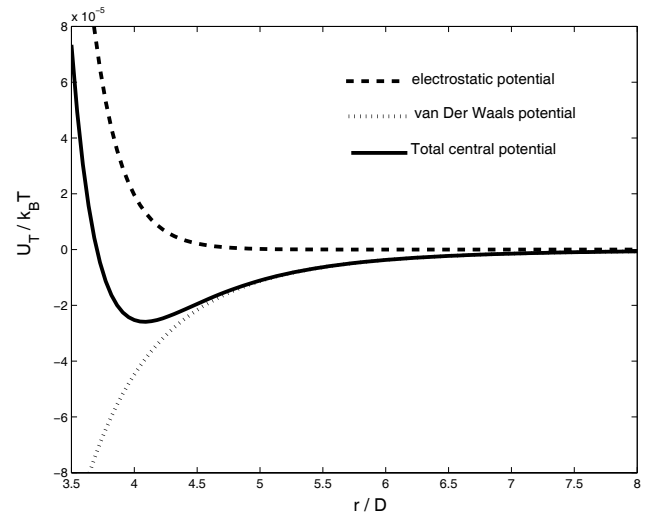

FIG. 4: Same as Fig. 3, but centered around the secondary minimum and in a much amplified energy scale.

interparticle average distance to the nearest neighbors is approximately equal to that corresponding to the secondary minimum. Larger values of  $\psi_0$  (lower pH) lead to higher potential barriers and smaller values of the depth of the secondary minimum. The Figs. 3 and 4 were calculated for  $\psi_0 = 60$  mV (pH = 4.5).

## D. Mechanisms of rotation of the magnetic moments

The typical size of the magnetic particles in a ferrofluid is on the order of  $10$  nm, sufficiently small for them to be magnetic monodomains. This is an important characteristic, because the particles have to have non-zero magnetic moments

for the ferrofluid to show its magnetic properties. A fundamental property of the magnetic fluids is that, in presence of a non-homogeneous magnetic field,  $\mathbf{B}(\mathbf{r})$ , they are attracted to the region where the field intensity is maximum. This happens because the magnetic moments,  $\boldsymbol{\mu}$ , rotate to the minimum energy direction ( $U = -\boldsymbol{\mu} \cdot \mathbf{B}$ ), which is parallel to the field. Then it is pulled by the force  $\mathbf{F} = \nabla \mathbf{B} \cdot \boldsymbol{\mu}$  in the direction of the field gradient.

Two distinct mechanisms exist for the rotation of the magnetic moments in magnetic fluids. One is the rotation of the magnetic particle inside the liquid carrier, known by the names of *Debye rotation* or *Brownian rotation*; this last name is because, even in absence of a magnetic field, the particle rotates due to the Brownian torques (molecular collisions), which causes rotational Brownian motion; the relaxation time for this rotation is, for spherical particles,  $\tau_B = 3V\eta/k_B T$  [3], where  $V$  is the particle's volume and  $\eta$  the liquid's viscosity. The other mechanism is the rotation of the magnetic moment with respect to the particle, known as *Neél rotation*. The relaxation time for this rotation is strongly dependent on the particle's volume and on the temperature, namely,  $\tau_N = f_0^{-1} \exp(KV/k_B T)$ , where  $f_0$  is the Larmor frequency and  $K$  is the anisotropy constant of the particle. In the case of magnetite particle [4],  $K = 1.1 \times 10^4 \text{ J/m}^3$ , at room temperature,  $\tau_N$  increases from  $4 \times 10^{-9} \text{ s}$  to  $7 \times 10^{-5} \text{ s}$  upon increasing the particle's diameter from  $10 \text{ nm}$  to  $20 \text{ nm}$ . When the Neél rotation is the dominant mechanism, i.e., when the magnetic moment is quasi-free to rotate, the particle is *superparamagnetic*. By lowering the temperature one comes to a temperature,  $T_B$ , known as *blocking temperature*, below which  $\tau_N$  is larger than the typical observation times. Below  $T_B$  the particle is not anymore superparamagnetic, but the magnetic fluid is still superparamagnetic because the particle, and so also  $\boldsymbol{\mu}$ , continues to be quasi-free to rotate. Equations of motion for  $\boldsymbol{\mu}$ , sufficiently general to be applicable for the cases of superparamagnetic and non-superparamagnetic particles, as well as mixed situations, where both mechanisms are important, can be found in the literature [22, 23].

Some hypothesis which are usually made in theoretical proposals for the rotational dynamics of the superparamagnetic particles and their magnetic moments in ferrofluids are:

- 1) The particle has a symmetry axis of easy magnetization, a unit vector along which is usually denoted by  $\mathbf{c}$ .
- 2) The magnetic moment  $\boldsymbol{\mu}$  has constant modulus,  $\mu$ , and rotates inside the particle in an uniaxial potential modeled by  $V = -K(\boldsymbol{\mu} \cdot \mathbf{c})^2$ , where  $K$  is known as *asymmetric constant*.
- 3) The particles' moment of inertia has a negligible contribution to the equations of rotational motion, in comparison with the Brownian torque and rotational dissipation terms.

An example of computer simulation of the rotational dynamics of the particles in ferrofluids may be found in Ref. [24], among others.

### E. Thermodiffusion in magnetic fluids

The thermodiffusion phenomena [25–28] is particularly interesting in magnetic colloids. When this originally homo-

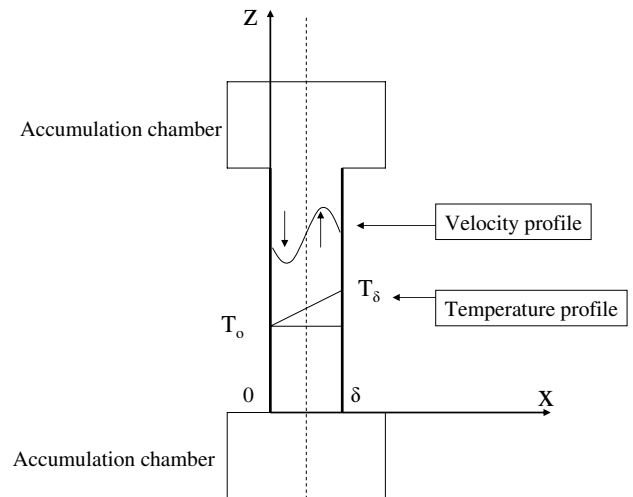

FIG. 5: Sketch of the experimental setup with the thermodiffusion column.

geneous material is subjected to a thermal gradient, there is a concentration current of magnetic particles parallel to the direction of the thermal gradient. Thermodiffusion, also called *Soret effect*, is characterized by the *Soret coefficient*  $S_T$  [27, 29–31], which represents the coupling between current of mass and temperature gradient. A great effort was done by several groups around the world to improve the understanding of the thermomagneto-phoretic mobility in ferrocolloids.

The Latvia group [32–34] used the vertical column method to calculate the thermal diffusion coefficient from the measurement of the grains separation in the column. The experimental setup of the thermodiffusion column (Fig. 5) consists in a vertical gap of thickness  $\delta$  (typically  $\sim 1 \text{ mm}$ ), where the sample is placed, positioned between two vertical parallel walls maintained at different temperatures. The temperature difference imposes convective flows at the walls in a way that an ascending stream is present near the warmer wall and a descending stream near the colder wall. Two separation chambers are placed at the ends of the column (upper and lower parts) where the grain's concentration are measured with the help of a LC oscillator. Depending on the sign of the flux of matter along the gap (the horizontal direction), ferrofluid grains will accumulate in the upper or lower chamber of the column.

The french group used a different experimental technique to investigate thermodiffusion in ferrofluids, the Forced Rayleigh Scattering (FRS). In experiments performed with the FRS technique, a thin colloid sample is placed in the interference pattern of two coherent intersecting pulsed pump laser beams (Fig. 6) [35, 36]. The space modulation of the light intensity generates by absorption processes, a modulation of temperature  $T$  which, in turn, generates a modulation of the nanograin volume-fraction  $\phi$  through the Soret effect.  $T$  and  $\phi$  profiles are analyzed by diffracting a cw probe laser beam on this double-origin index grating. Lenglet and co-workers

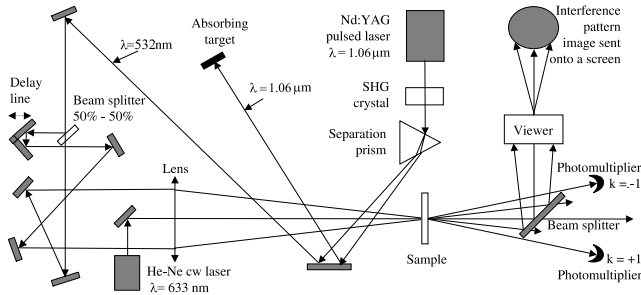

FIG. 6: Forced Rayleigh Scattering experimental setup.

[37, 38] measured  $S_T$  in different ferrofluids, obtaining values ranging from  $10^{-3}K^{-1}$  up to  $10^{-1}K^{-1}$ . Interestingly, the same temperature gradient gives positive or negative concentration gradients, depending on the particular ferrofluid under study. The following terminology was proposed in order to characterize different magnetic colloids with respect to the sign of  $S_T$  [39]: if the particles of a colloid tend to go away from the hottest region, it is named thermophobic ( $S_T > 0$ ); if the particles tend to concentrate in the hottest region, the colloid is named thermophilic ( $S_T < 0$ ).

Besides the column method and the forced Rayleigh scattering, the Z-Scan (ZS) technique [41] have been used to measure  $S_T$ . In the ZS technique [40] a polarized (chopped) Gaussian laser beam, propagating in the z-direction, is focused to a narrow waist by using lens. The sample is moved along the z-direction through the focal point and the transmitted intensity is measured in the far field using a photodiode behind a small calibrated pinhole, as a function of the z-position. A chopper provides a square-wave light profile with a periodic succession of ON and OFF states of equal duration. As the sample moves along the beam focus, self-focusing and defocusing modify the wave front phase, thereby modifying the detected beam intensity (the setup is sketched in Fig. 7). The variation of the index of refraction  $\Delta n(r,t)$ , where  $r$  is the radial distance from the beam axis, can be written as the sum of terms that arise from the temperature change ( $\Delta T$ ), the volume-fraction change ( $\Delta\phi$ ), and the light intensity  $I(r,t)$  on the sample. Each process which takes place in the sample has its typical characteristic time: the Soret effect  $t_S \sim \text{seconds}$ ; thermal lens effect  $t_c \sim \text{ms}$ ; and electronic effects  $t_e \sim \text{femtoseconds}$ . So, Z-Scan experiments with different time-scale square waves can be used to study these different processes. The experimental results obtained until now with the FRS and ZS techniques can be summarized as follows:

- the sign of  $S_T$  depends on the sign of the charge of the surface particles;
- in water-based SFF, the thermodiffusive behavior is opposite to that of IFF; i.e., particles coated with cationic surfactants behave as negatively charged IFF (alkaline) particles, and particles coated with anionic surfactants behave as positively charged IFF (acid) particles;

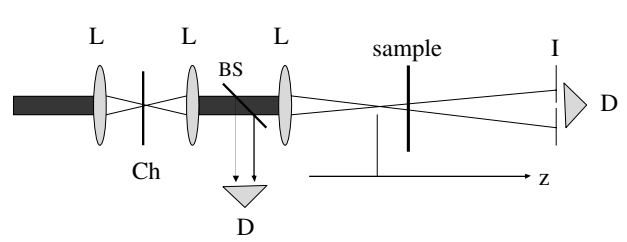

FIG. 7: Z-Scan experimental setup. L, Ch, BS, D and I are lens, chopper, beam-splitter, detector and iris, respectively. The z-axis is also indicated.

- SFF with particles coated with nonionic surfactants dispersed in nonpolar fluid carriers behave as SFF with particles coated with cationic surfactants;
- the nature of the liquid carrier itself is not the only determinant factor of the sign of  $S_T$ , except in the case of the nonpolar fluids, where  $S_T$  seems to be always positive.

In the case of the SFF (e.g., EMG607 from Ferrotec<sup>TM</sup> [8]), ZS experiments gave  $S_T/\phi = 4.4 \times 10^{-3}K^{-1}$ , where  $\phi$  is the volume fraction of magnetic particles. In other words,  $S_T$  seems to be proportional to  $\phi$  and, at  $\phi = 0.45 \times 10^{-2}$ ,  $S_T = (2.0 \pm 0.3) \times 10^{-5}K^{-1}$ . The proportionality between  $S_T$  and  $\phi$  was verified in others SFF and IFF [38].

These results still lack a comprehensive theoretical picture and, probably, different mechanisms take place in the thermodiffusive behavior of these complex fluids [39]. Bringuier and Bourdon [42] proposed a kinetic theory, based on the analysis of a Brownian motion in a nonuniform temperature profile, in order to predict both signs of the Soret coefficient.

## II. APPLICATIONS

A distinguishing feature of the research area in ferrofluids is the ample applicability of these materials. A big effort was made by chemists and physicists during a good part of last century to synthesize stable magnetic fluids, motivated by the perspective of many and important technological uses. Although non-stable suspensions of magnetic particles in liquids have been produced much earlier, the first synthesis of a ferrofluid was reported in the pioneering work by Papell [1], in 1965. After this, an increasing scientific production took place in the area. In Fig. 8 we reproduce a plot which we published [43] together with the bibliography on magnetic fluids for the Proceedings of the 10<sup>th</sup> International Conference on Magnetic Fluids, ICMF10, of the accumulated number of papers and patents published up to each year. A remarkable feature of this field is that the number of patents is about one half the number of papers, a clear confirmation to the perspective of ample applicability of ferrofluids.

The research field of magnetic fluids is a multi-disciplinary area: Chemists study their synthesis and produce the ferroflu-

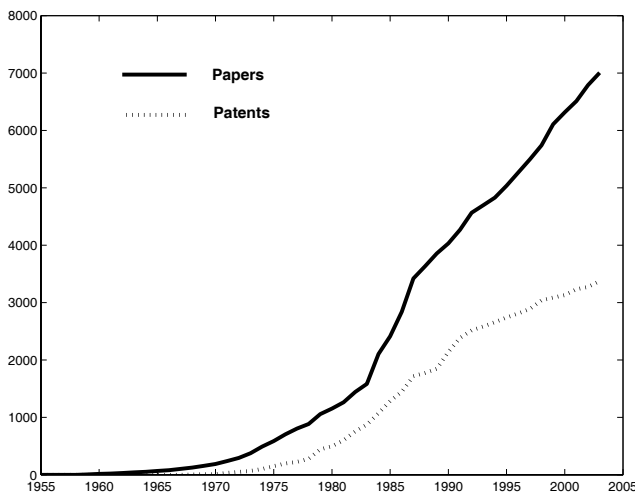

FIG. 8: Accumulated production of papers and patents on magnetic fluids up to every year.

ids, Physicists study their physical properties and propose theories which explain them, Engineers study their applicability and use them in technological products, Biologists and Physicians study their biomedical possibilities and use them in Medicine and in research on the biological area.

Most applications of magnetic fluid are based on the following of its properties:

- 1) It goes to where the magnetic field is strongest and stays there;
- 2) It absorbs electromagnetic energy at convenient frequencies and heats up;
- 3) Its physical properties may change with the application of a magnetic field;

These properties make the magnetic fluids useful for many technological, biological and medical purposes, as well as a help in materials science and engineering research. In the following sub-sections we comment on some of these applications.

### A. Technological Applications

Of the many technological applications of magnetic fluids we will single out four main categories: a) Dynamic sealing; b) Heat dissipation; c) Damping; d) Doping of technological materials.

#### 1. Dynamic Sealing

In many equipments there are two or more different ambients, which have to be hermetically isolated from each other but some shaft has to carry energy (rotation) from one ambient into the other. For example, a motor has to be in an open place, where it can be cooled down by the ambient air or some

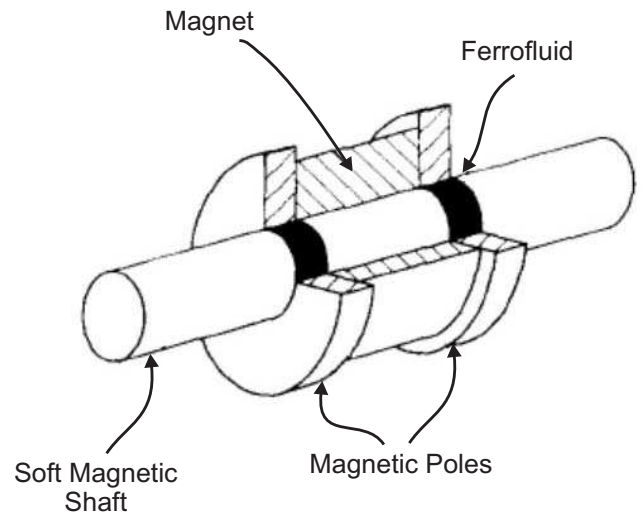

FIG. 9: Dynamic seal, reproduced from Raj and Moskowitz [44].

refrigeration mechanism, while a shaft has to go from it into an absolutely clean place, where it has to rotate something. This is the case, for example, of the hard disks of computers, which have to operate in an hermetically closed box because any grain of powder or even smoke may spoil the reading and writing process. Therefore it is necessary to seal hermetically the hole through which the axle passes. This is achieved by making the hole inside a magnet (see Fig. 9) and the shaft made of soft magnetic material. A groove in the shaft is filled up with ferrofluid, which is kept in place by the magnetic field, obstructing the passage of any impurity, but leaving the axle free to rotate, because the obstructing material is liquid.

#### 2. Heat dissipation

One way of extracting heat from an equipment which heats up by functioning, and so keeping it not too hot, is by using a good heat conductor which connects the equipment to some mass which has much bigger heat capacity and, perhaps, much bigger open surface to dissipate heat. In some cases the good heat conductor must not be a solid, because it would block the equipment's operation (for example, if it has to vibrate). One way to achieve the desired goal is by using a ferrofluid as heat conductor. A non magnetic liquid would flow away from the place where it is supposed to operate. A good example is a loudspeaker, whose coil heats up by functioning and the ferrofluid is kept in place by the magnetic field of the magnet which is fixed on the loudspeaker's horn. Nowadays most of the high power loudspeakers are equipped with ferrofluid. The presence of the fluid around the coil improves also the quality of the speaker because it damps unwanted resonances, which would produce a very unpleasant noise.

### 3. Inertial and viscous damper

We mentioned above that magnetic fluids are used also as dampers in loudspeakers. A more direct use for damping unwanted vibrations is associated to their use as inertial and viscous dampers for motors, mainly stepper motors. For this purpose use is made of the unique property of magnetic fluids that can keep a magnet, whose mass density is bigger than that of the fluid, floating in it, with part of its volume above the liquid's surface. This is because the magnetic field gradient pulls the magnetic fluid to the region under the immersed pole of the magnet, causing a pressure (magnetic pressure) which pushes the magnet up. The equilibrium is established when the magnet's weight is counterbalanced by this magnetic pressure and the hydrostatic pressure. Even a non-magnetic body can "levitate" if there is a magnetic field gradient applied on the ferrofluid, which causes a magnetic pressure gradient in the fluid [45]. A stepper motor operated at its natural frequency may experience excessive settling time, vibration and acoustic noise. A damper absorbs the unwanted vibration by a shearing effect which produces a torque that opposes the oscillatory motion. The damper has a non-magnetic housing which attaches to the motor shaft. Inside the housing is an inertial mass which levitates on ferrofluid, thus eliminating the need for bearings to support the mass [46].

## B. Materials research

Of the several possibilities of use of ferrofluids as a help on the study of materials, we have chosen to describe only the case of liquid crystals doping, which is made in one of our laboratories.

### 1. Magnetic colloids used to dope liquid crystals

The use of magnetic colloids to dope liquid crystals was proposed by Brochard and de Gennes [47] in a seminal paper in 1970. They proposed to introduce anisotropic magnetic nanoparticles ( $L/d \sim 10$ , where  $L$  and  $d$  are the length and the diameter of the cylindrical particles) in a liquid crystalline matrix. This doping should reduce by a factor of  $10^3$  [48] the magnetic field necessary to orient liquid crystals.

According to experimental observations with lyotropic nematic liquid crystals [49], above a minimum value of the concentration of particles,  $c_m$ , the liquid crystalline matrix collectively follows the orientation of the magnetic particles. Rault and co-workers [50] observed, for the first time, this macroscopic collective behavior in a nematic liquid crystal doped with magnetic microparticles (typical size larger than that of actual ferrofluids). This minimum concentration was shown to be  $c_m \sim 1/(LD_s^2)$  [47], where  $D_s$  is the thickness of the sample.

The doping of lyotropic liquid crystals with water-based surfactant ferrofluids was achieved in 1979 by Liébert and Martinet [51]. After that, this procedure was widely used to investigate different aspects of the physics of liquid crystals [49, 52–54]. Magnetic nanoparticles can be used to in-

vestigate dynamic processes in lyotropic ferronematics (nematic liquid crystals doped with ferrofluids), in particular the response of the nematic matrix to pulsed magnetic fields [55][56].

From the theoretical point of view, many authors faced the problem of the field-director coupling in a ferronematic liquid crystal [57–60]. Brochard and de Gennes showed that the mechanism responsible for the ferrofluid doped liquid crystal orientation is basically due to a mechanical coupling between magnetically oriented anisometric particles and the director [47]. Thermal fluctuations (at room temperature) overcome the eventual magnetic orientation of the liquid crystal molecules by the intrinsic particle magnetic moment field.

The first thermotropic ferronematic suspension was obtained by Rault and co-workers [50]. They mixed large  $\gamma$ - $\text{Fe}_2\text{O}_3$  magnetic stick-like particles ( $L = 0.35 \mu\text{m}$  long, with diameter  $d = 0.04 \text{ mm}$ ), coated with surfactant agents, to MBBA (p-methoxybenzilidene-p-n-butylaniline). Chen and Amer [61] doped the MBBA with similar particles ( $L = 0.5 \mu\text{m}$  long,  $L/d = 7$ ), coated with dimethyl octadecyl aminopropyl trimethoxysilyl chloride (DMOAP).

Since one of the basic substances of lyotropics is water, their doping with water-based ferrofluids is straightforward. Typical concentrations used in lyotropics, for many practical purposes, are  $c \sim 10^{13} \text{ particles/cm}^3$ . At this concentration, there were observations of no significant changes in the transition temperatures, birefringence and elastic constants with respect to pure liquid crystals.

### 2. Doping of lyotropic liquid crystals with magnetic particles

Ferronematic and ferrocholesteric lyotropic liquid crystals were prepared for the first time by Liébert and Martinet [51, 62] mixing a water-based surfactant ferrofluid ( $\text{Fe}_3\text{O}_4$  grains, with a mean diameter of  $15.4 \text{ nm}$ ) with lyotropic nematic and cholesteric mixtures. The collective behavior of the liquid crystalline matrices was observed with magnetic fields of about  $20 \text{ G}$ . The use of ferrofluids to orient lyotropics was essential in experiments in which the reciprocal structure of the biaxial nematic phase was determined [63].

The ferrofluid doping of nematic liquid crystals can be used to investigate elastic properties of liquid crystals. In particular, the bend elastic constant,  $k_{33}$ , and the anisotropy of the diamagnetic susceptibility,  $\chi_a$  can be measured by comparing the relaxation behavior of these complex fluids (liquid crystals with and without the ferrofluid doping) when subjected to different magnetic fields [64, 65]. The controversial subject of the effective splay-bend elastic constant,  $k_{13}$ , was also investigated using ferrofluid doped lyotropic samples [66]. The ratio between  $k_{13}$  and the usual Frank elastic constant found in the potassium laurate/decanol/water lyotropic mixture was positive and of the order of 1 [67].

Linear optical techniques are widely used to investigate the dynamic behavior of ferronematics as a function of time and strength of the applied magnetic field ( $\mathbf{H}$ ) [55]. In undoped nematics, the relaxation time is proportional to  $H^{-2}$  but in ferronematics, the relaxation time is proportional to  $H^{-1}$  [55, 56].

Moreover, the critical field of the Fréedericksz transition [68] of a ferronematic sample was found to be two orders of magnitude smaller than its value in undoped samples [69, 70].

Nonlinear optical properties of lyotropic liquid crystals were investigated by using ferrofluid doped samples [71, 72]. Ferrofluid particles significantly increase the sample light absorption, which is particularly useful to investigate the nonlinear behavior of complex fluids. The nonlinear refraction index  $n_2$  [73] of doped samples were shown to be 10 times larger than those of undoped samples.

Ferrocholesteric lyotropic liquid crystals are obtained by doping usual cholesterics with ferrofluids [54]. Both ionic and surfacted ferrofluids can be used for this purpose. Like the case of ferronematics, small magnetic fields (of about 10 G) are enough to orient discotic and biaxial cholesterics. Differently from the discotic and biaxial ferrocholesterics, the helix of calamitic ferrocholesterics is unwound by small magnetic fields [74].

Particles of  $\gamma$ -Fe<sub>2</sub>O<sub>3</sub> (diameter of 8 nm) coated with organophosphorated surfactants and dispersed in cyclohexane, were incorporated in a lyotropic lamellar phase [75–77]. Stable ferrolamellar phases, without the formation of aggregates and phase separation, were observed under some particular conditions, at  $\phi = 1.5\%$ . Magnetic particles are expected to accommodate in the hydrophobic region of the lamellar structure. The flexibility of the lamellae in ferrofluid doped samples was also investigated and compared to the undoped system [78]. The value of the bending elastic constant in doped samples is about 10 times larger than in undoped samples [78].

Quilliet and co-workers [79] succeeded to incorporate surfacted oil-based ferrofluids in a hexagonal lyotropic mesophase. However, a homogeneous phase was not achieved, with the microsegregation of part of the particles.

In the future, ferrofluid doped liquid crystals could be considered to be used in devices since the magneto-optical properties of these complex fluids are remarkable and the system responds to small magnetic fields.

## C. Biomedical Applications

In Biomedical applications one can also single out some main categories: a) Magnetic drug targeting; b) Hyperthermia; c) Contrast enhancement for Magnetic Resonance Imaging - MRI; d) Magnetic separation of cells.

### 1. Magnetic drug targeting

Localizability of a portion of ferrofluid by a magnetic field, associated with the fact that any liquid may be turned into a magnetic fluid, offers very interesting applicability in medicine. Much attention has been done to bounding on ferrofluids chemical drugs appropriate for chemotherapy. The idea is: such a ferrofluid bounded drug is injected in a cancer tumor and there it is kept during some time ( $\approx$  one hour) by a suitably focused magnetic field, where it has a very intense action.

The amount of drug necessary is much less than what would be necessary if it were dispersed in the whole body. When the magnetic field is turned off the drug will disperse in the body, but, since the total amount is very small, there will be practically no side effects. A paper by Lübbe *et.al.* [80] presents a wide variety of possibilities with this technique and offers a detailed classification of the treatments along these lines. In a more recent paper, Alexiou *et.al.* [81] report on application of ferrofluid bound Mitoxantrone in 26 tumor-bearing rabbits, showing absolute success in healing the tumor, without side effects.

### 2. Hyperthermia

The property of ferrofluids of absorbing electromagnetic energy at a frequency that is different from the frequency at which water absorbs energy allows one to heat up a localized portion of a living body, where ferrofluid has been injected, for example a tumor, without heating at the same time the surrounding parts of the body. A number of experiments, healing cancer tumors in rats and rabbits by this technique have been reported during the last few years [82]. In the year of 2004 a new important step was given in this direction: humans have had their cancer tumors successfully treated by magnetic fluid hyperthermia (MFH). A work entitled "Magnetic fluid hyperthermia (MFH): A new therapeutic option in the treatment of glioblastomas (GB)" was recently presented in the "55<sup>o</sup>Jahrestagung der Deutschen Gesellschaft für Neurochirurgie e.V. (DGNC)", in Köln. An experimental treatment of 15 patients, in association with a low dose radiotherapy, showed very good results; the treatment was well tolerated by the patients, leaving clear that it constitutes an important new weapon against cancer.

### 3. Contrast enhancement for Magnetic Resonance Imaging

MRI has been one of the most powerful diagnosis techniques used in medicine in recent years. Its ability to distinguish between different tissues relies on the different relaxation times  $T_2$  of the proton's magnetic moments when it is inside different ambients. Frequently, however, the differences are not strong enough to render well resolved images. If magnetic particles from a biocompatible ferrofluid are selectively absorbed by some kind of tissue, this will become very clearly visible by MRI. Moreover, different tissues uptake different amounts of the magnetic particles, having, therefore, different values of  $T_2$  and distinguishable images. Dextran coated iron oxides are biocompatible and are excreted via the liver after the treatment. They are selectively taken up by the reticuloendothelial system. This is important because tumor cells do not have the effective reticuloendothelial system of healthy cells, so that their relaxation time is not altered by the contrast agent, which makes them distinguishable from the surrounding healthy cells. Pankhurst *et.al.*, in a recent topical review on applications of magnetic nanoparticles in biomedicine [83], have listed a number of situations where the tech-



nique of MRI with ferrofluid contrast has been used with good results.

#### 4. Magnetic separation of cells

It is often advantageous to separate out specific biological entities from their native environment, for different possible reasons: to produce concentrated samples of these entities or to freed an infected sample from them. Magnetic separation using biocompatible magnetic particles from ferrofluids is one way to achieve this. It is a two-step process: 1) fixing a magnetic particle to the desired biological entity, and 2) pulling the magnetic particles, together with their "prey" out of the native environment by the action of a magnetic field gradient. Fixing the magnetic particle to the biological entity is made possible by coating the particle with an appropriate material, such as dextran, polyvinyl alcohol and others [83].

Uses of cell separation include clean up bone marrow from cancer infected samples taken from a person, aiming to use the purified samples to be implanted again in the same person, avoiding in this way the rejection, very common when the implanted material comes from a different donor. In this case, magnetic nanospheres are coated with monoclonal antibodies having an affinity for the tumor cells. When marrow removed from the patient is put in contact with the coated spheres in a liquid solution, the tumor cells selectively attach to the surface of the spheres, which are then magnetically separated from the solution [84].

### III. PROSPECTIVE FOR NEAR FUTURE RESEARCH ON FERROFLUIDS

It is, of course, impossible to predict with confidence how will be the research on ferrofluids in the next years. Some hints, however, may be inferred from the trends of this research in the last few years, up to now. Surely, the immense possibilities of applications of ferrofluids will continue to be explored. In particular, the biomedical applications, which until now have been based almost exclusively on experiments with small animals, is turning very rapidly to uses on humans. Treatment of cancer, in particular, is needing faster progress than has been achieved with traditional medicine, and the use of ferrofluids for drug targeting or hyperthermia or combining this techniques with traditional radiotherapy, chemotherapy or even surgery, will certainly be the subject of intense research in the next years. On the same line, synthesis of ferrofluids will focus strongly on biocompatible coatings, having affinities to different living cells. At the level of basic research, the very rapid progress of computer technology, which produces very fast, powerful and not expensive computers, as well as very convenient softwares, will be used in conjunction with more realistic models for numerical simulation, by this way predicting properties and qualities of ferrofluids, to be tested in the laboratory. Stochastic molecular dynamics have been used up to now very timidly. Associated with the hydrodynamic forces, stochastic molecular dynamics can lead to very realistic predictions for ferrofluids.

- 
- [1] S. S. Papell, U.S. Patent n° 3, **215**, 572 (1965);.
- [2] R. E. Rosensweig and R. Kaiser, NTIS Rep. No. NASW-1219 (1967).
- [3] R. E. Rosensweig, *Ferrohydrodynamics*, Cambridge Univ. Press, Cambridge, London (1985); republished by Dover.Publ.Inc., New York (1997).
- [4] *Magnetic Fluids and Applications Handbook*, edited by B. Berkovski and V. Bashtovoy, Begell House, Wallingford (1996).
- [5] M. Magalhães, A. M. Figueiredo Neto, A. Bee, and A. Bourdon, *J. Chem. Phys.* **113**, 10246 (2000).
- [6] U.S. Patent 3,843,540 (1974).
- [7] S. W. Charles and J. Popplewell, in *Ferromagnetic Material*, edited by E. P. Wohfarth, North-Holland Publishing Company, Vol. 2, Amsterdam (1980).
- [8] <http://www.ferrotec.com/usa/index.html>.
- [9] <http://www.sigma-hc.co.jp/english/index.html>.
- [10] R. Massart, *IEEE Trans. Magn.* **17**, 1247 (1981).
- [11] J. Depeyrot, G.J. da Silva, C.R. Alves, E.C. Sousa, M. Magalhães, A.M. Figueiredo Neto, M.H. Sousa, and F.A. Tourinho, *Braz. J. Phys.* **31**, 390 (2001).
- [12] R. Massart, E. Dubois, V. Cabuil, and E. Hasmonay, *J. Magn. Mater.* **149**, 1 (1995).
- [13] E. Dubois, PhD. Thesis, *Université Pierre et Marie Curie*, Paris 6 (1997).
- [14] E. Hasmonay, PhD. Thesis, *Université Pierre et Marie Curie*, Paris 6 (1998).
- [15] A. Bee, R. Massart, and S. Neveu, *J. Magn. Mater.* **149**, 6 (1995).
- [16] R. A. Buhrman and C. G. Granqvist, *J. Appl. Phys.* **47**, 2220 (1976).
- [17] J. C. Bacri, V. Cabuil, R. Massart, R. Perzynski, and D. Salin, *J. Magn. Mater.* **65**, 285 (1987).
- [18] ASTM Crystallography International Table, file n°39-1346.
- [19] M. H. Sousa, F. A. Tourinho, J. Depeyrot, G. J. da Silva, and M. C. F. L. Lara, *J. Phys. Chem.* **B105**, 1168 (2001).
- [20] P. C. Scholten, in *Colloid Chemistry of Magnetic Fluids in Thermomechanics of the Magnetic Fluids*, edited by B. Berkovski, Hemisphere Publ. Corp., Bristol (1978).
- [21] J. N. Israelachvili, *Intermolecular and Surface Forces* (Academic, New York, 1991).
- [22] M.I. Shliomis and V.I. Stepanov, *Adv. Chem. Phys. Series*, **87**, 1 (1994);
- [23] C. Scherer and G. Matuttis, *Phys. Rev.* **E63**, 011504 (2001);
- [24] C. Scherer, *Braz. J. Phys.*, **34**, 442 (2004);
- [25] Ch. Soret, *Arch. Sci. Phy. Nat.*, **2**, 48 (1879).
- [26] Ch. Soret, *Arch. Sci. Phy. Nat.*, **4**, 209 (1880).
- [27] S. R. De Groot, *L'Effet Soret, diffusion thermique dans les phases condensées*, Noord-Hollandsche Uitgevers Maatschappij, Amsterdam, (1945).
- [28] S. R. De Groot and P. Mazur, *Non-Equilibrium Thermodynamics*, North-Holland Publ. Co. Amsterdam, (1962).
- [29] K. Wada, A. Suzuki, H. Sato, and R. Kikuchi, *J. Phys. Chem. Solids* **46**, 1195 (1985).
- [30] S. A. Akbar, M. Kaburagi, and H. Sato, *J. Phys. Chem. Solids* **48**, 579 (1987).

- [31] L. Landau and E. Lifchitz, *Mécanique des Fluides*, Ed. Mir, Moscou (1971).
- [32] E. Blums, G. Kronkalns, and R. Ozols, *J. Magn. Magn. Matter.* **39**, 142 (1983).
- [33] E. Blums, Yu.A. Mikahailov, and R. Ozols, *Heat and Mass Transfer in MHD-Flows*, World Sci., Singapore (1987).
- [34] E. Blums, *J. Magn. Magn. Matter.* **149**, 111 (1995).
- [35] J.C. Bacri, A. Cebers, A. Bourdon, G. Demouchy, B.M. Heegard, and R. Perzinsky, *Phys. Rev. Lett.* **74**, 5032 (1995).
- [36] J.C. Bacri, A. Cebers, A. Bourdon, G. Demouchy, B.M. Heegard, B. Kashevsky, and R. Perzinsky, *Phys. Rev. E* **52**, 3936 (1995).
- [37] J. Lenglet, *These de doctorat de l'Université Paris 7 Denis Diderot*, Paris, France (1996).
- [38] J. Lenglet, A. Bourdon, J. C. Bacri, and G. Demouchy, *Phys. Rev. E* **65**, 031408-1-14 (2002).
- [39] S. Alves, G. Demouchy, A. Bee, D. Talbot, A. Bourdon, and A. M. Figueiredo Neto, *Philo. Mag.* **83**, 2059 (2003).
- [40] M. Sheik-Bahae, A.A. Said, T.H. Wei, D.J. Hagan, and E.W. van Stryland, *IEEE J. Quantum Electron.* **26**, 760, (1990).
- [41] S. Alves, A. Bourdon, and A. M. Figueiredo Neto, *J. Opt. Soc. Am. B* **20**, 713 (2003).
- [42] E. Bringuier and A. Bourdon, *Phys. Rev. E* **67**, 011404 (2003).
- [43] C.Scherer and J.A.Miranda, *Proceedings of the 10<sup>th</sup> international conference on magnetic fluids*, *J. Magn. Mag. Mat.* **289**, 484 (2005);
- [44] K. Raj and R. Moskowitz, "Commercial applications of ferrofluids", *Journal of Magnetism and Magnetic Materials.* **85**, 233 (1990)
- [45] V. Bashtovoi, "Static of Magnetic Fluids", Chapter 3 of reference [4]
- [46] K. Raj, "Magnetic Fluids and Devices: a Commercial Survey", Chapter 5 of reference[4]
- [47] F. Brochard and P. G. de Gennes, *J. Phys. (France)* **31**, 691 (1970).
- [48] P. G. de Gennes and J. Prost, *The Physics of Liquid Crystals*, Clarendon Press, Oxford (1993).
- [49] A. M. Figueiredo Neto and M. M. F. Saba, *Phys. Rev. A* **34**, 3483 (1986).
- [50] J. Rault, P. E. Cladis and J. P. Burger, *Phys. Lett. A* **32**, 199 (1970).
- [51] L. Liébert and A. Martinet, *J. Physique Lett.* **40**, L-363 (1979).
- [52] L. Liébert and A. M. Figueiredo Neto, *J. Physique Lett.* **45**, L-173 (1884).
- [53] A. M. Figueiredo Neto, in *Phase Transitions in Complex Fluids*, ed. by P. Tolédano and A. M. Figueiredo Neto (World Scientific, Singapore, pg. 175) (1998).
- [54] A. M. Figueiredo Neto and S. R. A. Salinas, *The Physics of Lyotropic Liquid Crystals: Phase Transitions and Structural Properties*, Monographs on the Physics and Chemistry of Materials 62, Oxford Science Publications, Oxford Univ. Press., London, UK (2005).
- [55] J. C. Bacri and A. M. Figueiredo Neto, *Phys. Rev. E* **50**, 3860 (1994).
- [56] E. A. Oliveira, A. M. Figueiredo Neto, and G. Durand, *Phys. Rev. A* **44**, R825 (1991).
- [57] S. V. Burylov and Y. L. Raikher, *Mol. Cryst. Liq. Cryst.* **258**, 107 (1995).
- [58] Y. L. Raikher and V. I. Stepanov, *J. Intel. Mat. syst. Str.* **7**, 550 (1996).
- [59] A. Yu. Zubarev and L. Yu. Iskakova, *Physica A* **229**, 203 (1996).
- [60] G. Barbero, A. M. Figueiredo Neto, and N. V. Madhusudana, *Phys. Lett. A* **251**, 373 (1999).
- [61] S. H. Chen and N.M. Amer, *Phys. Rev. Lett.* **51**, 2298 (1983).
- [62] L. Liébert and A. Martinet, *IEEE Trans. Mag.* **MAG-16**, 266 (1980).
- [63] Y. Galerne, A. M. Figueiredo Neto, and L. Liébert, *J. Chem. Phys.* **87**, 1851 (1987).
- [64] E. A. Oliveira, G. Barbero, and A. M. Figueiredo Neto, *Phys. Rev. E* **54**, 5830 (1996).
- [65] T. Kroin, A. J. Palangana, and A. M. Figueiredo Neto, *Phys. Rev. A* **39**, 5373 (1989).
- [66] J. Nehring and A. Saupe, *J. Chem. Phys.* **54**, 337 (1972).
- [67] S. Fontanini, A. L. Alexe-Ionescu, G. Barbero, and A. M. Figueiredo Neto, *J. Chem. Phys.* **106**, 6187 (1997).
- [68] E. B. Priestley, in *Introduction to Liquid Crystals*, edited by E. B. Priestley, P. I. Wojtowicz, and P. Sheng, Plenum Press, New York (1979).
- [69] V. Berejnov, J. C. Bacri, V. Cabuil, R. Perzynski, and Y. Raikher, *Europhys. Lett.* **41**, 507 (1998).
- [70] K. I. Morozov, *Phys. Rev. E* **66**, 011704 (2002).
- [71] S. L. Gómez and A. M. Figueiredo Neto, *Phys. Rev. E* **62**, 675 (2000).
- [72] S. L. Gómez, F. L. S. Cuppo, and A. M. Figueiredo Neto, *Braz. J. Phys.* **33**, 813 (2003).
- [73] I. C. Khoo, *Liquid Crystals: Physical Properties and Nonlinear Optical Phenomena* (Wiley, New York) (1987).
- [74] A. M. Figueiredo Neto, L. Liébert, and A. M. Levelut, *J. Phys. (France)* **45**, 1505 (1984).
- [75] P. Fabre, C. Casagrande, M. Veysie, V. Cabuil, and R. Massart, *Phys. Rev. Lett.* **64**, 539 (1990).
- [76] P. Fabre, *La Recherche* **21**, 1424 (1990).
- [77] C. Quilliet, P. Fabre, and V. Cabuil, *J. Phys. Chem.* **97**, 287 (1993).
- [78] V. Ponsinet and P. Fabre, *J. Phys. Chem.* **100**, 5035 (1996).
- [79] C. Quilliet, V. Ponsinet, and V. Cabuil, *J. Phys. Chem.* **98**, 3566 (1994).
- [80] A. S. Lübbe, C. Alexiou, and C. Bergemann, "Clinical Applications of Magnetic Drug Targeting", *Journal of Surgical Research* **95**, 200 (2001)
- [81] Ch. Alexiou, R. Schmid, R. Jurgons, Ch. Bergemann, W. Arnold and F.G. Parak, "Targeted Tumor Therapy with Magnetic Drug Targeting: Therapeutic Efficacy of Ferrofluid Bound Mitoxantrone", in "Ferrofluids: Magnetically Controllable Fluids and Their Applications", Ed. Stefan Odenbach, Springer, 2002, pg 233;
- [82] N. A. Brusentsov, L. V. Nikitin, T. N. Brusentsova, A. A. Kuznetsov, F. S. Bayburtskiy, L. I. Shumakov, and N. Y. Jurchenko "Magnetic fluid hyperthermia of the mouse experimental tumor", *Journal of Magnetism and Magnetic Materials*, **252**, 378 (2002)
- [83] Q.A. Pankhurst, J. Connolly, S.K. Jones, and J.Dobson, "Applications of magnetic nanoparticles in biomedicine", *J. Phys. D: Appl. Phys.*, **36**, R167 (2003).
- [84] R. E. Rosensweig, "Conceptual applications of magnetic fluids", Chapter 4 of reference [4].