

# Measurement of the top quark Yukawa coupling from $t\bar{t}$ kinematic distributions in the lepton + jets final state in proton-proton collisions at $\sqrt{s} = 13$ TeV

A. M. Sirunyan *et al.*\*  
(CMS Collaboration)

 (Received 2 July 2019; published 17 October 2019)

Results are presented for an extraction of the top quark Yukawa coupling from top quark-antiquark ( $t\bar{t}$ ) kinematic distributions in the lepton plus jets final state in proton-proton collisions, based on data collected by the CMS experiment at the LHC at  $\sqrt{s} = 13$  TeV, corresponding to an integrated luminosity of  $35.8 \text{ fb}^{-1}$ . Corrections from weak boson exchange, including Higgs bosons, between the top quarks can produce large distortions of differential distributions near the energy threshold of  $t\bar{t}$  production. Therefore, precise measurements of these distributions are sensitive to the Yukawa coupling. Top quark events are reconstructed with at least three jets in the final state, and a novel technique is introduced to reconstruct the  $t\bar{t}$  system for events with one missing jet. This technique enhances the experimental sensitivity in the low invariant mass region,  $M_{t\bar{t}}$ . The data yields in  $M_{t\bar{t}}$ , the rapidity difference  $|y_t - y_{\bar{t}}|$ , and the number of reconstructed jets are compared with distributions representing different Yukawa couplings. These comparisons are used to measure the ratio of the top quark Yukawa coupling to its standard model predicted value to be  $1.07^{+0.34}_{-0.43}$  with an upper limit of 1.67 at the 95% confidence level.

DOI: [10.1103/PhysRevD.100.072007](https://doi.org/10.1103/PhysRevD.100.072007)

## I. INTRODUCTION

The study of the properties of the Higgs boson, which is responsible for electroweak symmetry breaking, is one of the main goals of the LHC program. The standard model (SM) relates the mass of a fermion to its Yukawa coupling, i.e., the strength of its interaction with the Higgs boson, as  $g_f = \sqrt{2}m_f/v$ , where  $m_f$  is the fermion mass and  $v = 246.22$  GeV is the vacuum expectation value of the Higgs potential [1], obtained from a measurement of the  $\mu^+$  lifetime [2]. Since fermionic masses are not predicted by the SM, their values are only constrained by experimental observations. Given the measured value of the top quark mass of  $m_t = 172.4 \pm 0.5$  GeV [3], the top quark is the heaviest fermion and therefore provides access to the largest Yukawa coupling, which is expected to be close to unity in the SM. It is important to verify this prediction experimentally. We define  $Y_t$  as the ratio of the top quark Yukawa coupling to its SM value. In this definition,  $Y_t$  is equal to  $\kappa_t$  as defined in the “ $\kappa$  framework” [4], which introduces coupling modifiers to test for deviations in the SM couplings of the Higgs boson to other particles. Several

Higgs boson production processes are sensitive to  $Y_t$ , in particular Higgs boson production via gluon fusion [5,6] and Higgs boson production in association with top quark pairs,  $t\bar{t}H$  [7]. In both cases, in addition to  $Y_t$ , the rate depends on the Higgs boson coupling to the decay products, e.g., bottom quarks or  $\tau$  leptons. The only Higgs boson production process that is sensitive exclusively to  $Y_t$  is  $t\bar{t}H$  production with the Higgs boson decaying to a  $t\bar{t}$  pair, leading to a four top quark final state [8]. In this paper, we explore a complementary approach to measure  $Y_t$  independently of the Higgs coupling to other particles by utilizing a precise measurement of the top quark pair production cross section, which is affected by a virtual Higgs boson exchange. It has been shown that in the top quark pair production threshold region, which corresponds to a small relative velocity between the top quark and antiquark, the  $t\bar{t}$  cross section is sensitive to the top quark Yukawa coupling through weak force mediated corrections [9]. For example, doubling the Yukawa coupling would lead to a change in the observed differential cross section comparable to the current experimental precision of around 6% [10]. A detailed study of the differential  $t\bar{t}$  kinematic properties close to the production threshold could, therefore, determine the value of the top quark Yukawa coupling. This approach is similar to the threshold scan methods proposed for  $e^+e^-$  colliders [11,12].

We calculate the weak interaction correction factors for different values of  $Y_t$  using HATHOR (v2.1) [13] and apply

\*Full author list given at the end of the article.

Published by the American Physical Society under the terms of the [Creative Commons Attribution 4.0 International license](https://creativecommons.org/licenses/by/4.0/). Further distribution of this work must maintain attribution to the author(s) and the published article's title, journal citation, and DOI. Funded by SCOAP<sup>3</sup>.

them at the parton level to existing  $t\bar{t}$  simulated samples. From these modified simulations, we obtain distributions at detector level that can be directly compared to data. The Yukawa coupling is extracted from the distributions of the invariant mass of the top quark pair,  $M_{t\bar{t}}$ , and the rapidity difference between the top quark and antiquark,  $\Delta y_{t\bar{t}} = y_t - y_{\bar{t}}$ , for different jet multiplicities. The low  $M_{t\bar{t}}$  and small  $|\Delta y_{t\bar{t}}|$  regions are the most sensitive to  $Y_t$ .

Top quarks decay almost exclusively via  $t \rightarrow Wb$  and the final topology depends on the  $W$  boson decays. When one  $W$  boson decays leptonically and the other decays hadronically,  $t\bar{t} \rightarrow W^+bW^-\bar{b} \rightarrow \ell^+\nu b q\bar{q}'\bar{b} + \text{charge conjugate}$ , the final state at leading order (LO) consists of an isolated lepton (electron or muon in this analysis), missing transverse momentum (from the neutrino), and four jets (from two  $b$  quarks and two light quarks). This final state has a sizable branching fraction of 34%, low backgrounds, and allows for the kinematic reconstruction of the original top quark candidates. This analysis follows the methodology employed in Ref. [14] and introduces a novel algorithm to reconstruct the  $t\bar{t}$  pair when only three jets are detected.

The outline of this paper is as follows. Section II introduces the method of implementing the weak force corrections in simulated events as well as the variables sensitive to the top quark Yukawa coupling. Section III describes the CMS detector. The data and simulated samples used in the analysis are described in Sec. IV. The event selection criteria are discussed in Sec. V. The algorithm used to reconstruct  $t\bar{t}$  events is described in Sec. VI. Details on background estimation and event yields are covered in Secs. VII and VIII. The statistical methodologies and the systematic uncertainties are described in Secs. IX and X, respectively. Section XI presents the results of the fit to data. Section XII summarizes the results.

## II. WEAK INTERACTION CORRECTIONS TO $t\bar{t}$ PRODUCTION

Recent calculations provide next-to-next-to-leading-order (NNLO) predictions within the framework of perturbative quantum chromodynamics (QCD) for the  $t\bar{t}$  production cross section [15,16]. Photon-mediated corrections have been determined to be small [17]. The weak force corrections to the  $t\bar{t}$  production cross section were originally calculated [18] before the top quark discovery and were found to have a very small effect on the total cross section, so they are typically not implemented in Monte Carlo (MC) event generators. Nevertheless, they can have a sizable impact on differential distributions and on the top quark charge asymmetry. There is no interference term of order  $\alpha_s\alpha_{\text{weak}}$  between the lowest-order strong force mediated and neutral current amplitudes in the quark-induced processes. The weak force corrections start entering the cross section at loop-induced order  $\alpha_s^2\alpha_{\text{weak}}$  (as shown in Fig. 1). A majority of weak corrections do not depend on the top quark Yukawa coupling. Amplitudes

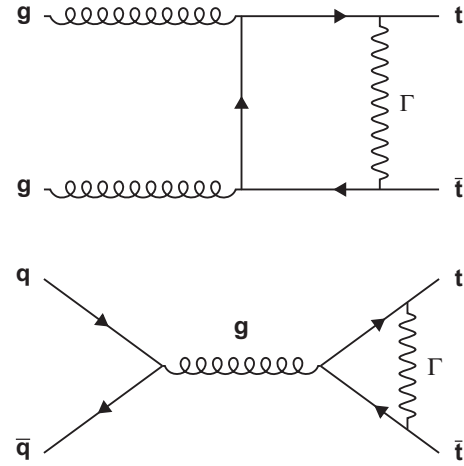

FIG. 1. Example of Feynman diagrams for gluon- and  $q\bar{q}$ -induced processes of  $t\bar{t}$  production and the virtual corrections. The symbol  $\Gamma$  stands for all contributions from gauge and Higgs boson exchanges.

linear in  $Y_t$ , which arise from the production of an intermediate  $s$ -channel Higgs boson through a closed  $b$  quark loop, can be ignored because of the small  $b$  quark

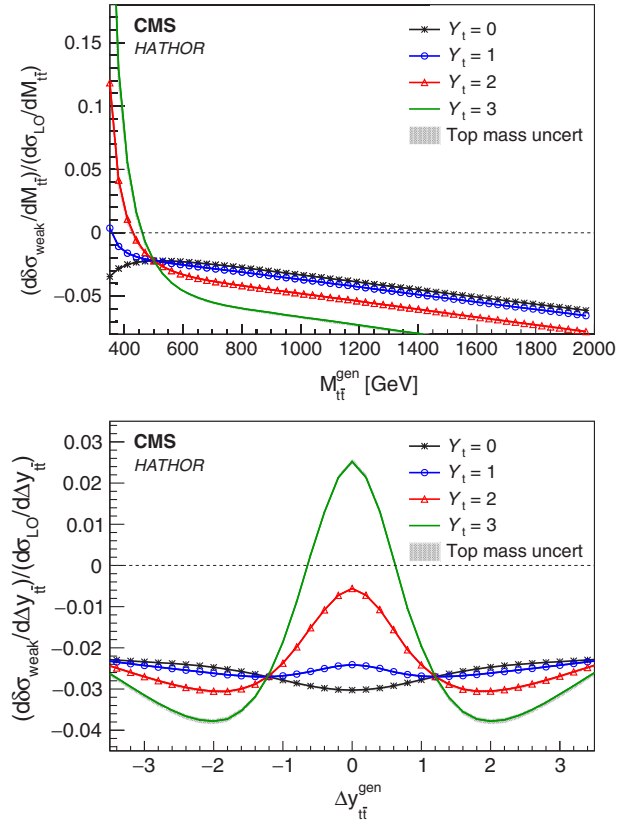

FIG. 2. The dependence of the ratio of weak force corrections over the LO QCD production cross section as calculated by HATHOR on the sensitive kinematic variables  $M_{t\bar{t}}$  and  $\Delta y_{t\bar{t}}$  at the generator level for different values of  $Y_t$ . The lines contain an uncertainty band (generally not visible) derived from the dependence of the weak correction on the top quark mass varied by  $\pm 1$  GeV.

mass. However, the amplitude of the Higgs boson contribution to the loop ( $\Gamma = H$  in Fig. 1) is proportional to  $Y_t^2$ . The interference of this process with the Born-level  $t\bar{t}$  production has a cross section proportional to  $\alpha_S^2 Y_t^2$ . Thus, in some kinematic regions, the weak corrections become large and may lead to significant distortions of differential distributions.

The HATHOR generator calculates the partonic cross section value, including the next-to-leading-order (NLO) weak corrections at order  $\mathcal{O}(\alpha_S^2 \alpha_{\text{weak}})$  for given  $M_{t\bar{t}}$  and  $|\Delta y_{t\bar{t}}|$ . The mass of the top quark is fixed at  $m_t = 172.5$  GeV, and its uncertainty is treated as a source of systematic uncertainty. We use HATHOR to extract a two-dimensional correction factor that contains the ratio of the  $t\bar{t}$  production cross section with weak corrections over the LO QCD production cross section in bins of  $M_{t\bar{t}}$  and  $|\Delta y_{t\bar{t}}|$ . This is done for different hypothesized values of  $Y_t$ , as shown in projections in Fig. 2. The largest effects arise near the  $t\bar{t}$  production threshold region and can be as high as 12% for  $Y_t = 2$ . We then apply this correction factor at the parton level as a weight to each  $t\bar{t}$  event simulated with POWHEG (v2) [19–22]. In the distributions at the detector level, the experimental resolutions and the systematic uncertainties, which are especially significant in the low- $M_{t\bar{t}}$  region, will reduce the sensitivity to this effect.

### III. THE CMS DETECTOR

The central feature of the CMS detector is a superconducting solenoid of 6 m internal diameter, providing a magnetic field of 3.8 T. Within the solenoid volume are a silicon pixel and strip tracker, a lead tungstate crystal electromagnetic calorimeter (ECAL), and a brass and scintillator hadron calorimeter (HCAL), each composed of a barrel and two endcap sections. Forward calorimeters extend the coverage provided by the barrel and endcap detectors. Muons are measured in gas-ionization detectors embedded in the steel flux-return yoke outside the solenoid. A more detailed description of the CMS detector, together with a definition of the coordinate system and relevant kinematical variables, can be found in Ref. [23].

The particle-flow (PF) algorithm [24] reconstructs and identifies each individual particle with an optimized combination of information from the various elements of the detector systems. The energy of photons is directly obtained from the ECAL measurements, corrected for zero-suppression effects. The energy of electrons is determined from a combination of the electron momentum at the primary interaction vertex as determined by the tracker, the energy of the corresponding ECAL cluster, and the energy sum of all bremsstrahlung photons spatially compatible with originating from the electron track. The momentum of muons is obtained from the curvature of the corresponding track, combining information from the silicon tracker and the muon system. The energy of charged hadrons is determined from a combination of their momentum

measured in the tracker and the matching ECAL and HCAL energy deposits, corrected for zero-suppression effects and for the response function of the calorimeters to hadronic showers. Finally, the energy of neutral hadrons is obtained from the corresponding corrected ECAL and HCAL energy. The reconstructed vertex with the largest value of the sum of the physics objects transverse momentum squared,  $p_T^2$ , is taken to be the primary proton-proton ( $pp$ ) interaction vertex.

### IV. DATA SET AND MODELING

The data used for this analysis corresponds to an integrated luminosity of  $35.8 \text{ fb}^{-1}$  at a center-of-mass energy of 13 TeV. Events are selected if they pass single-lepton triggers [25]. These require a transverse momentum  $p_T > 27$  GeV for electrons and  $p_T > 24$  GeV for muons, each within pseudorapidity  $|\eta| < 2.4$ , as well as various quality and isolation criteria.

The MC event generator POWHEG is used to simulate  $t\bar{t}$  events. It calculates up to NLO QCD matrix elements and uses PYTHIA (v8.205) [26] with the CUETP8M2T4 tune [27] for the parton shower simulations. The default parametrization of the parton distribution functions (PDFs) used in all simulations is NNPDF3.0 [28]. A top quark mass of 172.5 GeV is used. When compared to the data, the simulation is normalized to an inclusive  $t\bar{t}$  production cross section of  $832_{-46}^{+40}$  pb [29]. This value is calculated at NNLO accuracy, including the resummation of next-to-next-to-leading-logarithmic soft gluon terms. The quoted uncertainty is from the choice of hadronization, factorization, and renormalization scales and the PDF uncertainties.

The background processes are modeled using the same techniques. The MADGRAPH5\_aMC@NLO generator [30] is used to simulate  $W$  boson and Drell–Yan (DY) production in association with jets and  $t$ -channel single top quark production. The POWHEG generator is used to simulate a single top quark produced in association with a  $W$  boson ( $Wt$ ), and PYTHIA is used for QCD multijet production. In all cases, the parton shower and the hadronization are simulated by PYTHIA. The  $W$  boson and DY backgrounds are normalized to their NNLO cross sections calculated with FEWZ [31]. The cross sections of single top quark processes are normalized to NLO calculations [32,33], and the QCD multijet simulation is normalized to the LO cross section from PYTHIA. As explained in Sec. VII, the shape and the overall normalization of the QCD multijet contribution to the background are derived using data in a control region. The QCD multijet simulation is only used to determine relative contributions from different regions.

The detector response is simulated using GEANT4 [34]. The same algorithms that are applied to the collider data are used to reconstruct the simulated data. Multiple proton-proton interactions per bunch crossing (pileup) are included in the simulation. To correct the simulation to be in agreement with the pileup conditions observed during



the data taking, the average number of pileup events is calculated for the measured instantaneous luminosity. The simulated events are weighted, depending on their number of pileup interactions, to reproduce the measured pileup distribution.

## V. EVENT RECONSTRUCTION AND SELECTION

Jets are reconstructed from the PF candidates and are clustered by the anti- $k_T$  algorithm [35,36] with a distance parameter  $R = 0.4$ . The jet momentum is determined as the vectorial sum of the momenta of all PF candidates in the jet. An offset correction is applied to jet energies to take into account the contribution from pileup within the same or nearby bunch crossings. Jet energy corrections are derived from simulation and are improved with *in situ* measurements of the energy balance in dijet, QCD multijet, photon + jet, and leptonically decaying  $Z$  + jet events [37,38]. Additional selection criteria are applied to each event to remove spurious jetlike features originating from isolated noise patterns in certain HCAL and ECAL regions [39].

Jets are identified as originating from  $b$  quarks using the combined secondary vertex algorithm (CSV) v2 [40]. Data samples are used to measure the probability of correctly identifying jets as originating from  $b$  quarks ( $b$  tagging efficiency), and the probability of misidentifying jets originating from light-flavor partons ( $u$ ,  $d$ ,  $s$  quarks or gluons) or a charm quark as a  $b$ -tagged jet (the light-flavor and charm mistag probabilities) [40]. To identify a jet as a  $b$  jet, its CSV discriminant is required to be greater than 0.85. This working point yields a  $b$  tagging efficiency of 63% for jets with  $p_T$  typical of  $t\bar{t}$  events, and charm and light-flavor mistag probabilities of approximately 12 and 2%, respectively (around 3% in total).

The missing transverse momentum,  $\vec{p}_T^{\text{miss}}$ , is calculated as the negative vector sum of the transverse momenta of all PF candidates in an event. The energy scale corrections applied to jets are propagated to  $\vec{p}_T^{\text{miss}}$ . Its magnitude is referred to as  $p_T^{\text{miss}}$ .

Candidate signal events are defined by the presence of a muon or an electron that is isolated from other activity in the event, specifically jets, and  $\vec{p}_T^{\text{miss}}$  associated with a neutrino. The isolation variables exclude the contributions from the physics object itself and from pileup events. The efficiencies of lepton identification and selection criteria are derived using a tag-and-probe method in  $p_T$  and  $\eta$  regions [41]. The same lepton isolation criteria described in Ref. [14] are followed here.

To reduce the background contributions and to optimize the  $t\bar{t}$  reconstruction, additional requirements on the events are imposed. Only events with exactly one isolated muon [42] or electron [43] with  $p_T > 30$  GeV and  $|\eta| < 2.4$  are selected; no additional isolated muons or electrons with  $p_T > 15$  GeV and  $|\eta| < 2.4$  are allowed; at least three jets with  $p_T > 30$  GeV and  $|\eta| < 2.4$  are required, and at least

two of them must be  $b$  tagged. The  $W$  boson transverse mass, defined as  $M_T(W) = \sqrt{2p_T^\ell p_T^{\text{miss}} [1 - \cos(\Delta\phi_{\ell, \vec{p}_T^{\text{miss}}})]}$ , is required to be less than 140 GeV, where  $p_T^\ell$  is the transverse momentum of the lepton. For  $t\bar{t}$  events with only three jets in the final state, the  $p_T$  of the leading  $b$ -tagged jet is required to be greater than 50 GeV.

## VI. RECONSTRUCTION OF THE TOP QUARK-ANTIQUARK SYSTEM

The goal of reconstructing  $t\bar{t}$  events is to determine the top quark and antiquark four-momenta. For this, it is necessary to correctly match the final-state objects to the top quark and antiquark decay products. We always assume that the two  $b$ -tagged jets with the highest CSV discriminant values are associated with the two  $b$  quarks from  $t\bar{t}$  decays. For each event, we test the possible assignments of jets as  $t\bar{t}$  decay products and select the one with the highest value of a likelihood discriminant constructed based on the available information.

The first step in building the likelihood discriminant is to reconstruct the neutrino four-momentum  $p_\nu$  based on the measured  $\vec{p}_T^{\text{miss}}$ , the lepton momentum  $p_\ell$ , and the momentum  $p_{b_\ell}$  of the jet associated with the  $b$  quark from the top quark decay. The neutrino solver algorithm [44] uses a geometric approach to find all possible solutions for the neutrino momentum based on the two mass constraints  $(p_\nu + p_\ell)^2 = m_W^2 = (80.4 \text{ GeV})^2$  and  $(p_\nu + p_\ell + p_{b_\ell})^2 = m_t^2$ . Each equation describes an ellipsoid in the three-dimensional neutrino momentum space. The intersection of these two ellipsoids is usually an ellipse. We select  $p_\nu$  as the point on the ellipse for which the distance  $D_{\nu, \text{min}}$  between the ellipse projection onto the transverse plane ( $p_{\nu x}$ ,  $p_{\nu y}$ ) and the measured  $\vec{p}_T^{\text{miss}}$  is minimal. The algorithm leads to a unique solution for the longitudinal component of the neutrino momentum and an improved resolution for its transverse component. When the invariant mass of the lepton and the  $b_\ell$  candidate is above  $m_t$ , no solution can be found and this jet assignment is discarded. If both  $b_\ell$  candidates fail this requirement, then the event is rejected. The algorithm is applied for each of the two  $b$  jet possibilities and the minimum distance  $D_{\nu, \text{min}}$  is used to identify the correct  $b$  jet in the leptonic top quark decay,  $b_\ell$ , as described below.

### A. Reconstruction of events with at least four jets

The likelihood discriminant for events with at least four reconstructed jets is built to minimize the calculated  $D_{\nu, \text{min}}$ , and to simultaneously ensure that the invariant mass of the two jets hypothesized to originate from the  $W$  boson decay ( $M_{W_h}$ ) is consistent with the  $W$  boson mass, and that the invariant mass of the three jets hypothesized to originate from the hadronically decaying top quark ( $M_{t_h}$ ) is consistent with  $m_t$ . The likelihood discriminant for events with at least four jets,  $\lambda_4$ , is constructed as

$$-\ln[\lambda_4] = -\ln[P_m(M_{W_h}, M_{t_h})] - \ln[P_\nu(D_{\nu,\min})], \quad (1)$$

where  $P_m$  is the two-dimensional probability density to correctly reconstruct the  $W$  boson and top quark invariant masses, and  $P_\nu$  is the probability density describing the distribution of  $D_{\nu,\min}$  for a correctly selected  $b_\ell$ . On average, the distance  $D_{\nu,\min}$  for a correctly selected  $b_\ell$  is smaller and has a lower tail compared to the distance obtained for other jets. Jet assignments with values of  $D_{\nu,\min} > 150$  GeV are rejected since they are very unlikely to originate from a correct  $b_\ell$  association. The distributions from which  $P_m$  and  $P_\nu$  are derived, together with  $\lambda_4$  are shown in Figs. 2 (top-left), 2 (bottom-left) and 4 (left) of Ref. [14], respectively.

The efficiency of the reconstruction algorithm is defined as the probability that the most likely assignment, as identified by the largest value of  $\lambda_4$ , is the correct one, given that all decay products from the  $t\bar{t}$  decay are reconstructed and selected. Since the number of possible assignments increases drastically with the number of jets, it is more likely to select a wrong assignment if there are additional jets. The algorithm identifies the correct assignment in around 84% of the four-jet events, 69% of the five-jet events, and 53% of the six-jet events.

### B. Reconstruction of events with exactly three jets

The most sensitive region of the phase space to probe the size of the top quark Yukawa coupling is at the threshold of  $t\bar{t}$  production. However, the efficiency for selecting  $t\bar{t}$  events in this region is rather low, since one or more quarks from the  $t\bar{t}$  decay are likely to have  $p_T$  or  $\eta$  outside of the selection thresholds resulting in a missing jet. To mitigate this effect, an algorithm was developed for the reconstruction of  $t\bar{t}$  events with one missing jet [45].

As the missing jet in 93% of the selected three-jet events is associated with a quark from the  $W$  boson decay, we assume the two jets with the highest CSV discriminant are associated with  $b$  quarks from the  $t\bar{t}$  decay. The remaining two-fold ambiguity is in the assignment of the  $b$ -tagged jets: which one originates from the hadronic and which one from the semileptonic top quark decay. For each of the two possible  $b$  jet assignments, the algorithm uses the neutrino solver to calculate the corresponding minimum distance  $D_{\nu,\min}$ . If the neutrino solver yields no solution, this jet assignment is discarded and the other solution is used if available. Events with no solutions are discarded. If both  $b$  jet candidates have solutions for neutrino momentum, a likelihood discriminant is constructed using the minimum distance  $D_{\nu,\min}$  and the invariant mass  $M_{t_h}$  of the two jets hypothesized to belong to the hadronic top quark decay. We choose the jet assignment with the lowest value of the negative log likelihood  $-\ln[\lambda_3]$  defined as

$$-\ln[\lambda_3] = -\ln[P_{M_h}] - \ln[P_\nu(D_{\nu,\min})], \quad (2)$$

where the label 3 refers to the requirement of three jets. The function  $P_\nu(D_{\nu,\min})$  is the probability density of  $D_{\nu,\min}$  to correctly identify  $b_\ell$ , and  $P_{M_h}$  is the probability density of

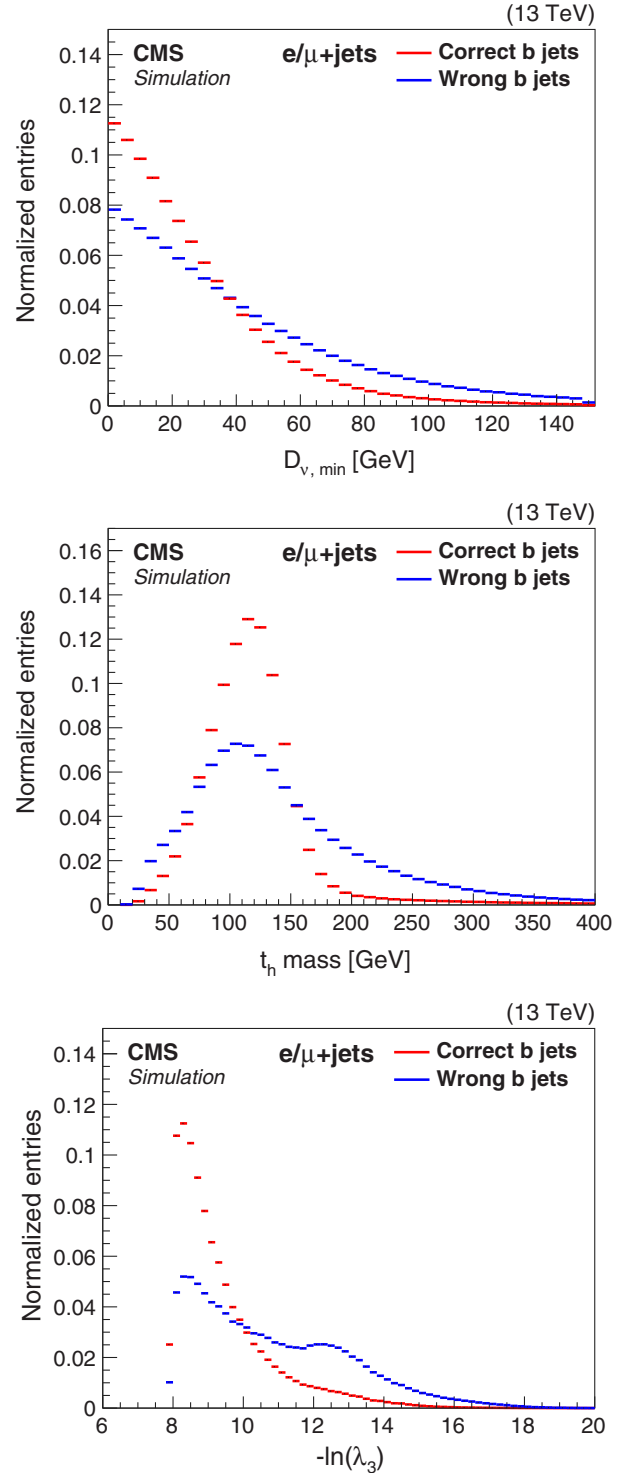

FIG. 3. Three-jet reconstruction. Distributions of the distance  $D_{\nu,\min}$  for correctly and wrongly selected  $b_\ell$  candidates (top). Mass distribution of the correctly and wrongly selected  $b_h$  and the jet from the  $W$  boson (middle). Distribution of the negative combined log-likelihood (bottom). All distributions are normalized to have unit area.

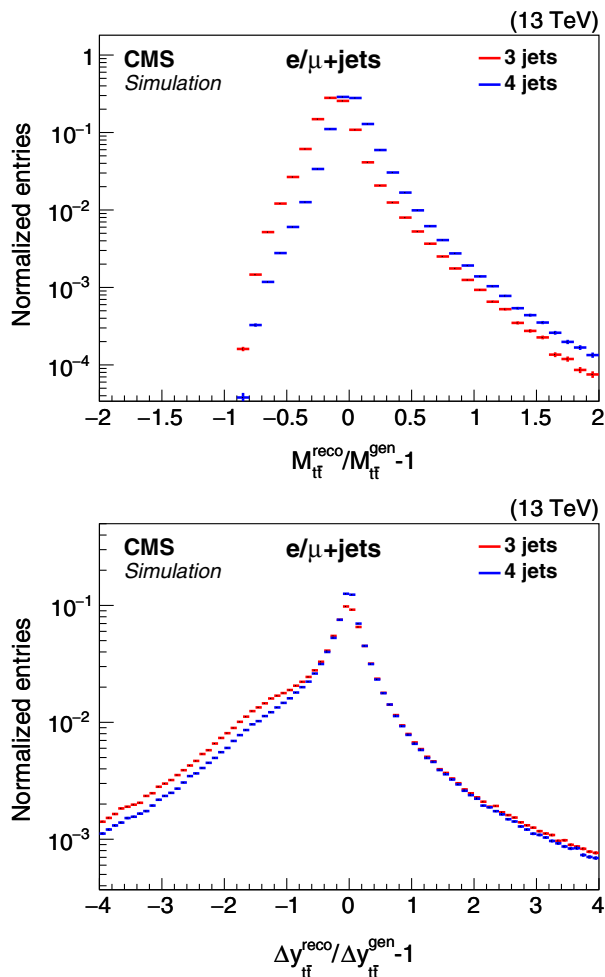

FIG. 4. Relative difference between the reconstructed and generated  $M_{t\bar{t}}$  (top) and  $\Delta y_{t\bar{t}}$  (bottom) for three-jet and four-jet event categories.

the invariant mass of the hypothesized  $b_h$  and the jet from the  $W$  boson decay. Figures 3 (top) and (middle) show the separation between correct and incorrect  $b$  assignments in the relevant variables for signal events. The distribution of  $-\ln[\lambda_3]$  is shown in the right plot of Fig. 3. Jet assignments with values of  $-\ln[\lambda_3] > 13$  are discarded to improve the signal-to-background ratio. Overall, this algorithm identifies the correct  $b$  jet assignment in 80% of three-jet events.

Semileptonic top quark decays are fully reconstructible, regardless of whether the event has three or four jets. The hadronically decaying top quark candidate in the missing jet category is approximated by the system of two jets identified to be associated with the hadronic top quark decay. Figure 4 shows the relative difference between the reconstructed and generated invariant mass of the  $t\bar{t}$  system and of the difference in rapidity for three-jet events, compared to those with four jets. Because of the missing jet, the observed value of  $M_{t\bar{t}}$  in the three-jet category tends to be lower than in the four-jet category. However, this shift does not affect the  $Y_t$  measurement since the data are compared to the simulation in each different jet multiplicity

bin: only the widths of these distributions are important. Figure 4 demonstrates that the three-jet reconstruction is competitive with the one achieved in the four-jet category.

To summarize, the newly developed three-jet reconstruction algorithm allows us to increase the yields in the sensitive low- $M_{t\bar{t}}$  region. As will be shown in Sec. X, the addition of three-jet events also helps to reduce the systematic uncertainty from effects that cause migration between jet multiplicity bins, e.g., jet energy scale variation and the hadronization model. The analysis is performed in three independent channels based on the jet multiplicity of the event: three, four, and five or more jets.

## VII. BACKGROUND ESTIMATION

The backgrounds in this analysis arise from QCD multijet production, single top quark production, and vector boson production in association with jets ( $V + \text{jets}$ ). The expected number of events from  $WW$  and  $WZ$  production is negligible and we ignore this contribution in the signal region (SR).

The contributions from single top quark and  $V + \text{jets}$  production are estimated from the simulated samples. Rather than relying on the relatively small simulated sample of QCD multijet events, smoother distributions in  $M_{t\bar{t}}$  and  $|\Delta y_{t\bar{t}}|$  are obtained from data in a control region (CR). Events in the CR are selected in the same way as the signal events, except that the maximum value of the CSV discriminant of jets in each event has to be less than 0.6. Hence, events in the CR originate predominately from  $V + \text{jets}$  and QCD multijet processes. The simulation in this background-enriched CR describes the data well within uncertainties. We take the distributions in  $M_{t\bar{t}}$  and  $|\Delta y_{t\bar{t}}|$  from data in the CR, after subtracting the expected contribution from the  $V + \text{jets}$ , single top quark,  $t\bar{t}$ , and  $WW$  and  $WZ$  processes. To obtain distributions in the SR, the distributions in the CR are then normalized by the ratio of the number of events in the SR ( $N_{\text{QCDMC}}^{\text{SR}}$ ) and CR ( $N_{\text{QCDMC}}^{\text{CR}}$ ) determined from simulated QCD multijet events:

$$N_{\text{QCD}}^{\text{SR}} = N_{\text{resDATA}}^{\text{CR}} \frac{N_{\text{QCDMC}}^{\text{SR}}}{N_{\text{QCDMC}}^{\text{CR}}}, \quad (3)$$

where  $N_{\text{resDATA}}^{\text{CR}}$  is the residual yield in data (after subtracting the background contributions not from QCD multijet). The SR-to-CR simulated events ratio in Eq. (3) is  $0.043 \pm 0.014$ ,  $0.041 \pm 0.012$ , and  $0.081 \pm 0.015$  for three, four, and five or more jets, respectively. The normalization uncertainty is estimated to be 30%. The shape uncertainty due to the CR definition is evaluated by selecting events for which the lepton fails the isolation requirement. The uncertainty is defined by the difference between the distributions of events that pass or fail the CSV discriminant requirement and can be as large as 60% in some regions of phase space.

TABLE I. Expected and observed yields after event selection and  $t\bar{t}$  reconstruction, with statistical uncertainties in the expected yields. The QCD multijet yield is derived from Eq. (3) and its uncertainty is the statistical uncertainty in the control region from the data-based QCD multijet determination described in Sec. VII.

Source	3 jets	4 jets	$\geq 5$ jets
$t\bar{t}$ right reco	$130\,520 \pm 150$	$92\,900 \pm 130$	$71\,640 \pm 110$
$t\bar{t}$ wrong reco	$29\,298 \pm 73$	$17\,356 \pm 57$	$43\,073 \pm 89$
$t\bar{t}$ nonreco	$50\,695 \pm 96$	$88\,760 \pm 130$	$80\,960 \pm 120$
$t\bar{t}$ background	$53\,465 \pm 99$	$26\,085 \pm 69$	$25\,047 \pm 68$
Single $t$	$17\,849 \pm 40$	$6922 \pm 27$	$6294 \pm 26$
V + jets	$8990 \pm 100$	$2824 \pm 52$	$2478 \pm 49$
QCD multijet	$19\,840 \pm 69$	$2100 \pm 25$	$1080 \pm 30$
Expected sum	$310\,650 \pm 250$	$236\,950 \pm 210$	$230\,570 \pm 210$
Data	308 932	237 491	226 788

### VIII. EVENT YIELDS AND CONTROL PLOTS

Table I shows the expected and observed event yields after event selection and  $t\bar{t}$  reconstruction, including the statistical uncertainties in the expected yields. All of the  $t\bar{t}$  components depend on the top quark Yukawa coupling from the production, so all of them are considered as signal. Here, the signal simulation is divided into the following categories: correctly reconstructed  $t\bar{t}$  systems ( $t\bar{t}$  right reco); events where all required decay products are available, but the algorithm failed to identify the correct jet assignments ( $t\bar{t}$  wrong reco);  $\ell$  + jets  $t\bar{t}$  events where at least one required decay product is missing ( $t\bar{t}$  nonreconstructible); and  $t\bar{t}$  events from dileptonic,  $W \rightarrow \tau\nu$ , or fully hadronic decays ( $t\bar{t}$  background).

Figures 5–7 show the comparison of data and simulation for  $\vec{p}_T^{\text{miss}}$ , the pseudorapidity of the lepton, and several kinematic variables of the top quarks and  $t\bar{t}$  system. In general, good agreement between data and prediction is observed. The data appear to have a deficit for high top quark  $p_T$  with respect to the available MC generators. This trend has been observed before in Refs. [46,47] and [14,48] both at 8 and 13 TeV, and recent differential NNLO calculations [49,50] reduce the discrepancy.

### IX. DETERMINATION OF $Y_t$

The two-dimensional data distributions in  $(M_{t\bar{t}}, |\Delta y_{t\bar{t}}|)$  are fit to the sum of the predicted contributions to infer the value of  $Y_t$  for events with three, four, and five or more jets in the final state. The bin limits are selected to capture the different behavior of the weak interaction correction, as seen in Fig. 2. There are three bins in  $|\Delta y_{t\bar{t}}|$ : 0–0.6, 0.6–1.2, and  $>1.2$ . A minimum of 10 000 simulated events are required in each  $(M_{t\bar{t}}, |\Delta y_{t\bar{t}}|)$  bin. This results in 21, 17, and 17 bins for event categories with three, four, and five or more jets, respectively.

The likelihood function is constructed as a product of Poisson distributions for the observed number of events,  $n_{\text{obs}}^{\text{bin}}$ , in each  $(M_{t\bar{t}}, |\Delta y_{t\bar{t}}|)$  bin [51]:

$$\begin{aligned} \mathcal{L}(Y_t, \theta) &= \prod_{\text{bin} \in (M_{t\bar{t}}, |\Delta y_{t\bar{t}}|)} \mathcal{L}^{\text{bin}} \\ &= \prod_{\text{bin}} \text{Pois}(n_{\text{obs}}^{\text{bin}} | s^{\text{bin}}(\theta) R^{\text{bin}}(Y_t, \theta) + b^{\text{bin}}(\theta)) \rho(\theta), \end{aligned} \quad (4)$$

where  $s^{\text{bin}}$  is the POWHEG prediction for the number of signal  $t\bar{t}$  events;  $b^{\text{bin}}$  is the prediction for the number of events from all background process (single top quark, V + jets, and QCD multijet production);  $R^{\text{bin}}(Y_t, \theta) = s^{\text{bin}}(Y_t)/s^{\text{bin}}(\text{POWHEG})$  encodes the effect of different  $Y_t$  coupling scenarios, parametrized with a quadratic dependence on  $Y_t$  in each bin (shown in Figs. 8 and 9 for the first  $|\Delta y_{t\bar{t}}|$  bin); and  $\theta$  represents the full suite of nuisance parameters with  $\rho(\theta)$  described by lognormal distributions parametrizing the uncertainty on each source. The different sources of systematic uncertainties are described in detail in Sec. X. The quantity  $R^{\text{bin}}(Y_t, \theta)$  is the main parameter of interest in the fit, as it represents the strength of the weak correction over the uncorrected POWHEG yields.

### X. SYSTEMATIC UNCERTAINTIES

We describe here the different sources of experimental and theoretical uncertainties and their effect on determining  $Y_t$ .

Systematic uncertainties that do not alter the shape of the distributions of  $M_{t\bar{t}}$  and  $\Delta y_{t\bar{t}}$  are treated as normalization uncertainties, while the others are treated as shape uncertainties. The latter are evaluated bin-by-bin in the likelihood function Eq. (4). Table II lists all the systematic uncertainties.

The uncertainty in the integrated luminosity is 2.5% [52]. The simulated samples are reweighted to match the measured data distribution in the number of pileup events. The uncertainty in the total inelastic  $pp$  cross section, which affects the pileup estimate, is accounted for by varying the average number of pileup events per bunch crossing by 5% [53].

The lepton efficiency scale factors, which account for the differences in the trigger, reconstruction, and identification efficiencies between data and simulation, are measured using a tag-and-probe method in  $Z \rightarrow \ell^+ \ell^-$  events [43,54]. These scale factors, measured in bins of lepton  $p_T$ , lepton  $\eta$ , and jet multiplicity, are applied to the simulated events. The overall uncertainty in the final measurement from these lepton scale factors is approximately 2%.

The uncertainties in the jet energy calibration (JEC) are evaluated by shifting the energies of jets in simulation up and down by one standard deviation in bins of  $p_T$  and  $\eta$ . Accounting for different sources of JEC uncertainties and jet flavors, a total of 19 shape variations are considered. The uncertainty in the jet energy resolution (JER) is calculated by broadening the resolution in simulation



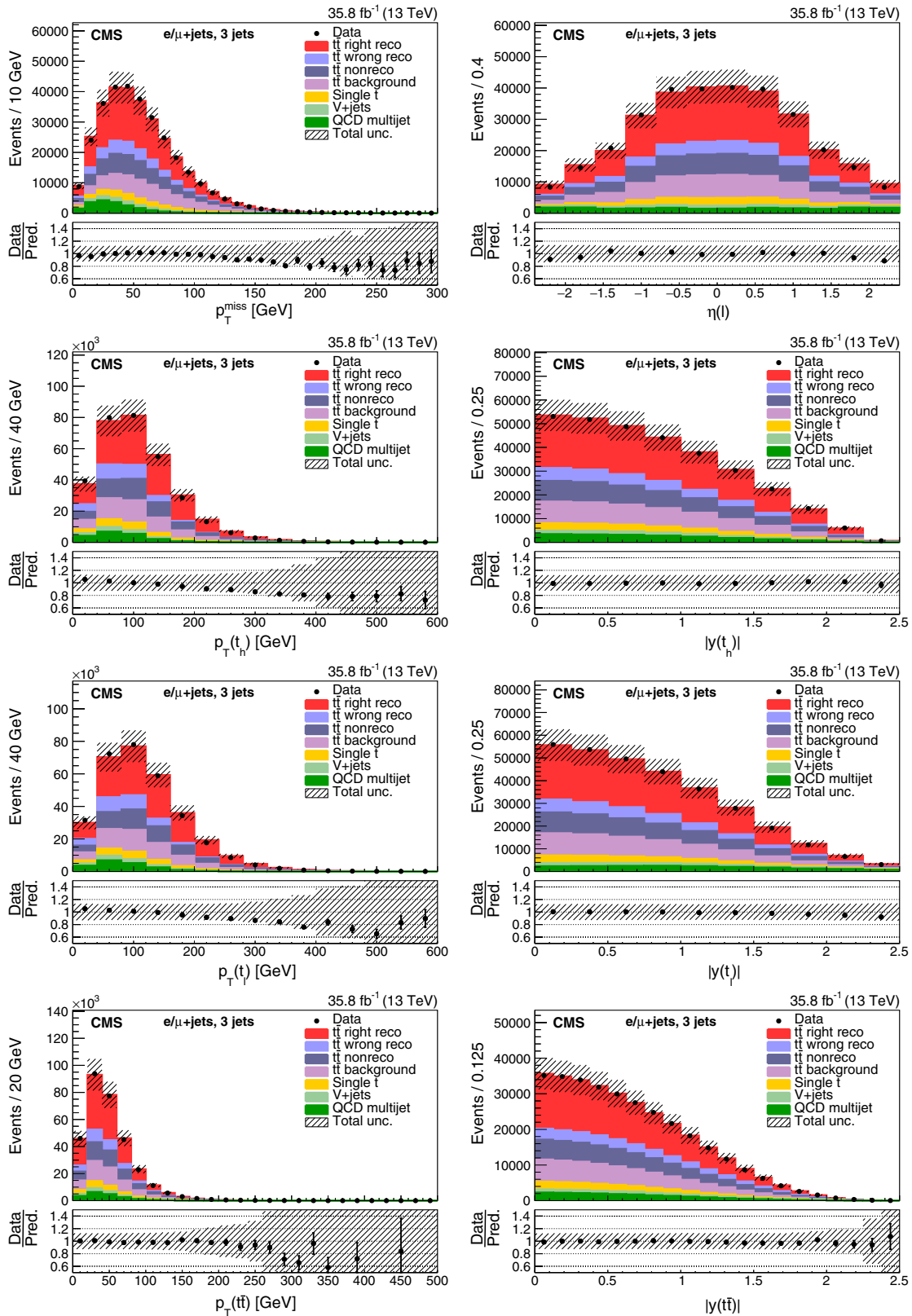
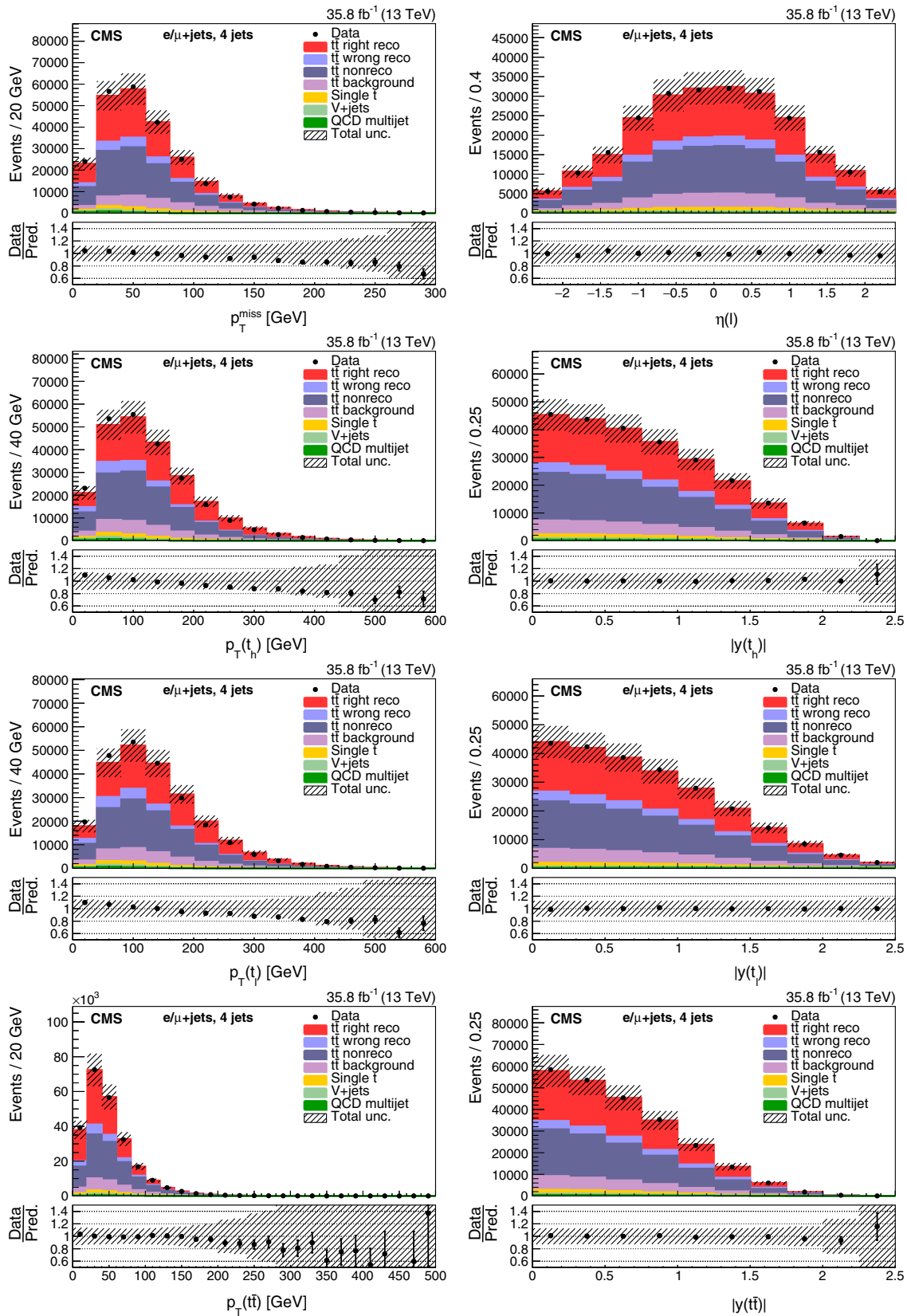

FIG. 5. Three-jet events after selection and  $t\bar{t}$  reconstruction. The plots show (left to right, upper to lower) the missing transverse momentum ( $p_T^{\text{miss}}$ ), the lepton pseudorapidity, and  $p_T$  and the absolute rapidity of the top quark decaying hadronically, semileptonically, and of the  $t\bar{t}$  system. The hatched band shows the total uncertainty associated with the signal and background predictions with the individual sources of uncertainty assumed to be uncorrelated. The ratios of data to the sum of the predicted yields are provided at the bottom of each panel.



 FIG. 6. Four-jet events after selection and  $t\bar{t}$  reconstruction. Same distributions as described in Fig. 5.

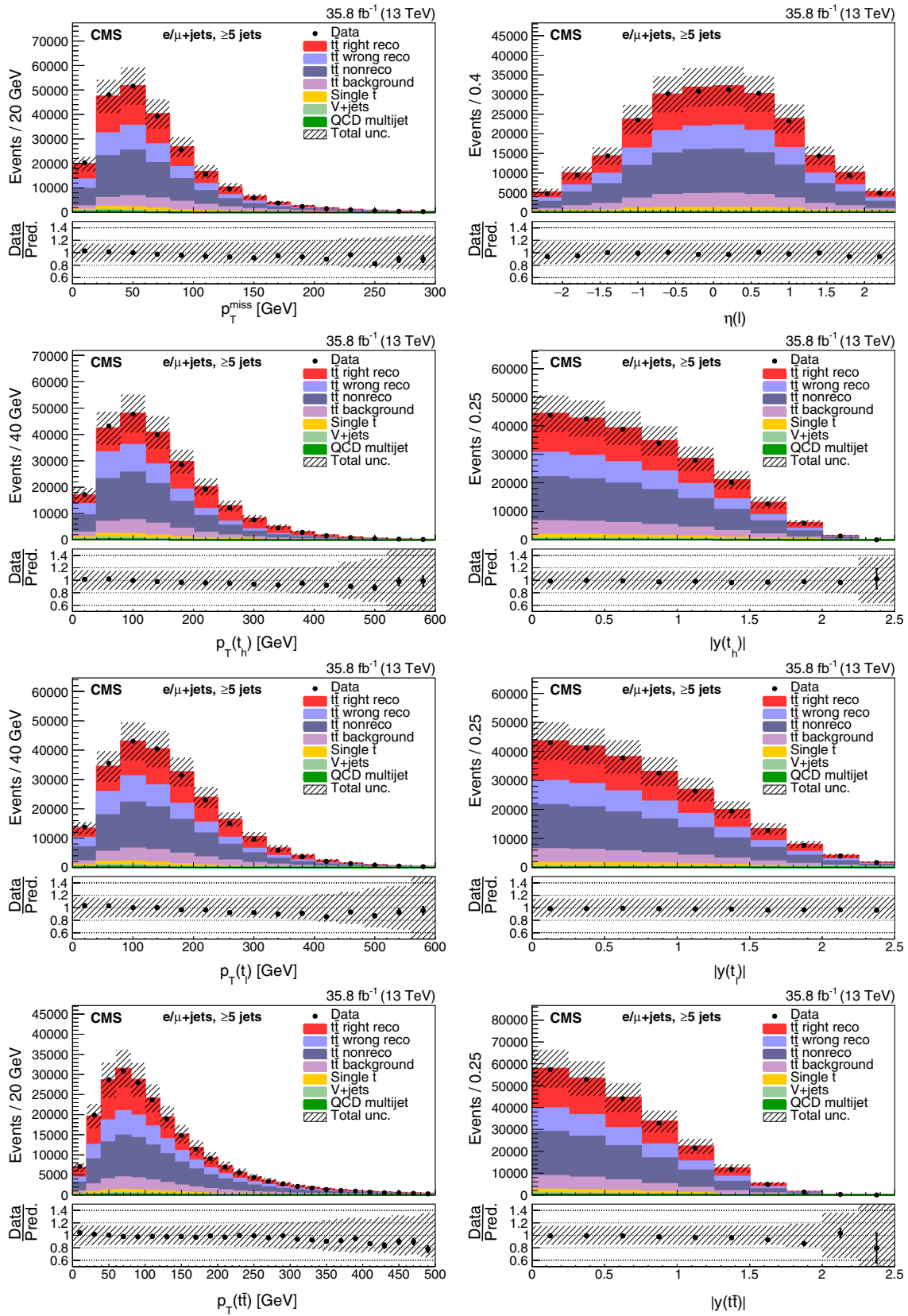

FIG. 7. Events with five or more jets after selection and  $t\bar{t}$  reconstruction. Same distributions as described in Fig. 5.

and recomputing the acceptances [38], for which the resulting effect is a change of less than 1% in event yields. The  $b$  tagging efficiency in the simulation is corrected using scale factors in bins of jet  $p_T$  and  $\eta$  determined from efficiencies measured in data and simulation [40]. The uncertainty in the measured scale factors ranges between 1% and 20% per jet, leading to an overall effect on the final measurement of 2%–3%.

The single top quark background estimate is affected by a 15% normalization uncertainty, evaluated from the combined results of  $t$ -channel and  $Wt$  productions [55,56]. The systematic uncertainty in the  $V + \text{jets}$  background prediction is 30%, derived from the leading contribution in the signal region:  $W$ +heavy flavor production [57]. The systematic uncertainties described above for the

signal are also derived for these background estimates. The QCD multijet background estimates from the data CR include a 30% normalization uncertainty from Eq. (3), and a shape difference observed between samples with different lepton isolation (as described in Sec. VII). The uncertainty from the determination of  $p_T^{\text{miss}}$  due to the electron, muon, and unclustered energy uncertainties, results in a negligible effect on the acceptance. All the major experimental uncertainties described above are evaluated for each process in all reconstruction channels.

In the following, we describe the theoretical uncertainties. The uncertainties in the factorization and renormalization scales affect the number of events expected in simulated samples. These are evaluated by varying each scale independently up and down by a factor of two.

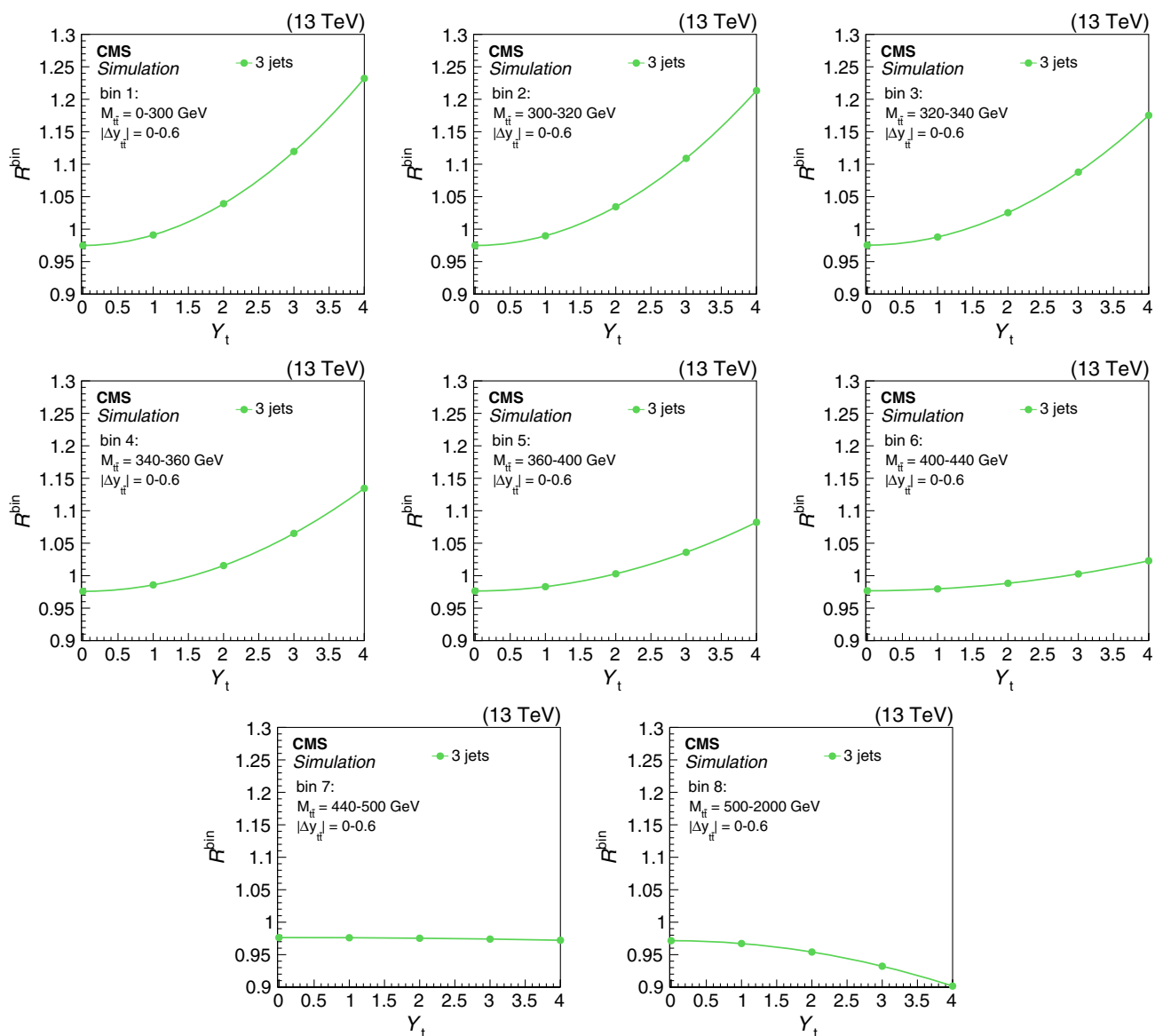

FIG. 8. The strength of the weak interaction correction, relative to the predicted POWHEG signal,  $R^{\text{bin}}$ , as a function of  $Y_t$  in the three-jet category. The plots correspond to the first eight  $M_{t\bar{t}}$  bins for  $|\Delta y_{t\bar{t}}| < 0.6$  (as shown in Fig. 10). A quadratic fit is performed in each bin.

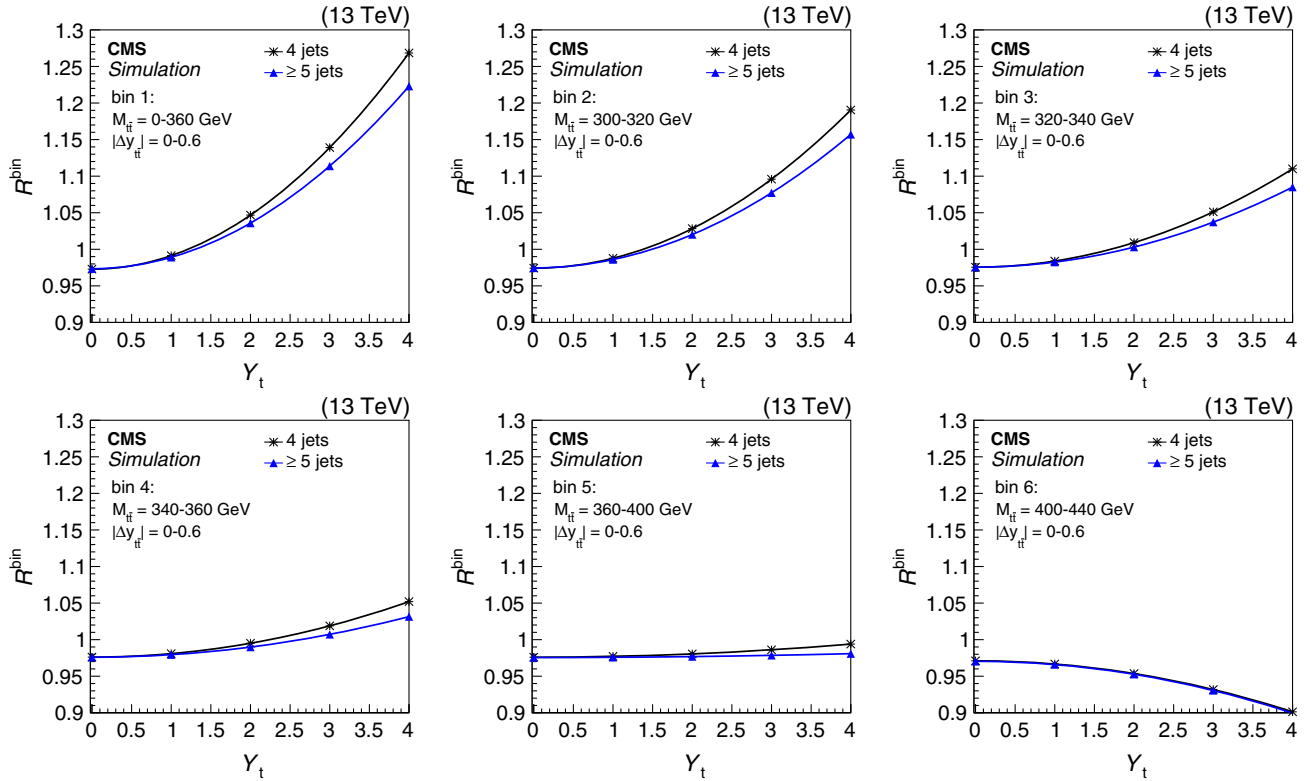

FIG. 9. The strength of the weak interaction correction, relative to the predicted POWHEG signal,  $R^{\text{bin}}$ , as a function of  $Y_t$  in the categories with four and five or more jets. The plots correspond to the first six  $M_{\bar{t}t}$  bins for  $|\Delta y_{\bar{t}t}| < 0.6$  (as shown in Fig. 10). A quadratic fit is performed in each bin.

TABLE II. Summary of the sources of systematic uncertainty, their effects and magnitudes on signal and backgrounds. If the uncertainty shows a shape dependence in the  $M_{\bar{t}t}$  and  $\Delta y_{\bar{t}t}$  distributions, it is treated as such in the likelihood. Only the luminosity, background normalization, and ISR uncertainties are not considered as shape uncertainties.

Uncertainty	$\bar{t}\bar{t}$	Single $t$	V + jets	QCD multijet
Integrated luminosity	2.5%	2.5%	2.5%	2.5%
Pileup	0–1%	0–1%	...	...
Lepton identification/trigger	1.9%	1.9%	1.9%	...
JEC	0–5%	0–5%	...	...
JER	0–0.6%	...	...	...
$b$ tag scale factor	3%	3%	2–3%	...
$b$ mistag scale factor	0.5%	1%	3–6%	...
Background normalization	...	15%	30%	30%
QCD multijet CR definition	...	...	...	0–60%
Factorization and renormalization scales	0–6%	2–5%	0–15%	...
PDF	0.5–1.5%	0.5–1.5%	...	...
$\alpha_s(m_Z)$ in PDFs	1%	1.5%	...	...
Top quark mass	1–5%	...	...	...
Top quark $p_T$ modeling	0–0.5%	...	...	...
Parton shower				
-NLO shower matching	1.5–5%	...	...	...
-ISR	2–3%	...	...	...
-FSR	0–9%	0–12%	...	...
-Color reconnection	0–3%	...	...	...
- $b$ jet fragmentation	0–3%	0–5%	...	...
- $b$ hadron branching fraction	3%	2.5–3%	...	...
Weak correction $\delta_{\text{QCD}}\delta_W$	0–0.2% ( $Y_t = 2$ )	...	...	...



We consider separate variations of the renormalization and factorization scales by taking the envelope of the observed variations as the quoted uncertainty. To account for possible correlation between the two sources of uncertainty, we also add an additional shape nuisance parameter that corresponds to the simultaneous variation of both parameters. The different replicas in the NNPDF3.0 PDF set [28] are used to estimate the corresponding uncertainty in the shape from the changed acceptance in each bin, which amounts to a combined variation as large as 5%. The different replicas due to the variation of strong coupling constant  $\alpha_s$  result in changes of the acceptance of around 1%.

The effect of the top quark mass experimental uncertainty is estimated by the difference in simulations generated with  $m_t$  varied by  $\pm 1$  GeV [3,58], and it results in a shape variation as large as 7%. The dependence of  $M_{\bar{t}\bar{t}}$  and  $\Delta y_{\bar{t}\bar{t}}$  on the correct description of the top quark  $p_T$  in the simulation is taken into account by checking the difference in the acceptance when the nominal POWHEG NLO samples are scaled to match the average top quark and antiquark  $p_T$  distributions calculated at NNLO in  $\alpha_s$  in Ref. [59]. This uncertainty is treated as a shape nuisance parameter in the likelihood function for the  $\bar{t}\bar{t}$  samples.

There are several sources of uncertainties arising from the parton shower modeling. The uncertainty in matching the matrix element calculation to the parton shower is estimated by changing the parameter that regulates the damping of real emissions in the NLO calculation [60], resulting in an effect of 1%–5%. The scales, which determine initial- (ISR) and final-state radiation (FSR) are also varied [27], resulting in a maximum change of 4% in the acceptance and shape variations as large as 10%. The uncertainty resulting from the modeling of the amount of multiple parton interactions is derived following the studies of Ref. [60] and is found to have a negligible effect on the result. Color reconnection reconfigures color strings after the parton shower, affecting the hadronic  $W$  boson decays [60]. This source of uncertainty typically results in shape differences smaller than 1%. The uncertainty in  $b$  quark fragmentation, the momentum transfer from the  $b$  quark to the  $b$  hadron, is estimated by varying the parametrized function in the PYTHIA simulation. It can produce a shape variation as large as 3%. As the  $b$  hadron semileptonic branching fractions may change the  $b$  jet energy response, the acceptance is recalculated after varying the  $B^+$ ,  $B^0$ ,  $B_s$ , and  $\Lambda_b$  semileptonic branching fractions up and

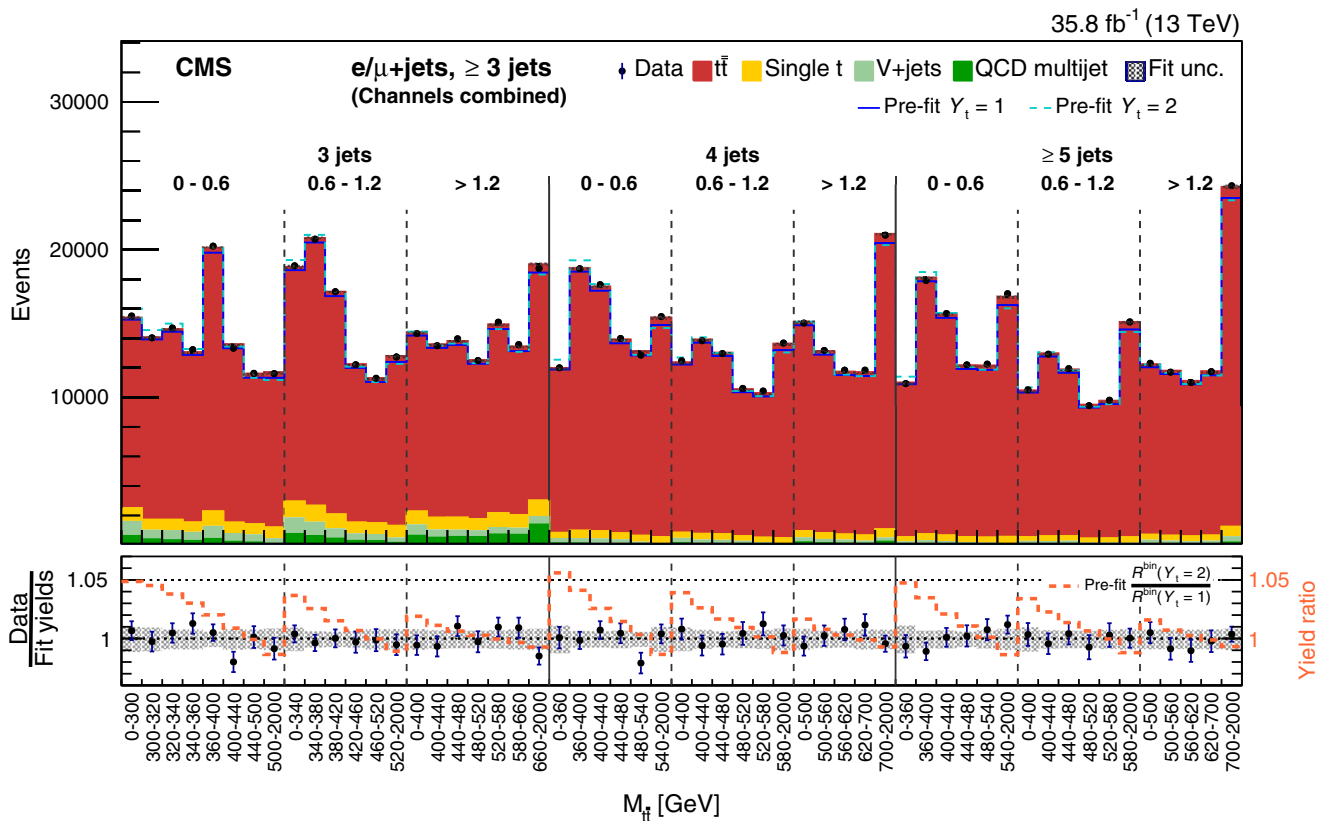

FIG. 10. The  $M_{\bar{t}\bar{t}}$  distribution in  $|\Delta y_{\bar{t}\bar{t}}|$  bins for all events combined, after the simultaneous likelihood fit in all jet channels. The hatched bands show the total postfit uncertainty. The ratios of data to the sum of the predicted yields are provided in the lower panel. To show the sensitivity of the data to  $Y_t = 1$  and  $Y_t = 2$ , the prefit yields are shown in the upper panel, and the yield ratio  $R^{\text{bin}}(Y_t = 2)/R^{\text{bin}}(Y_t = 1)$  in the lower panel.

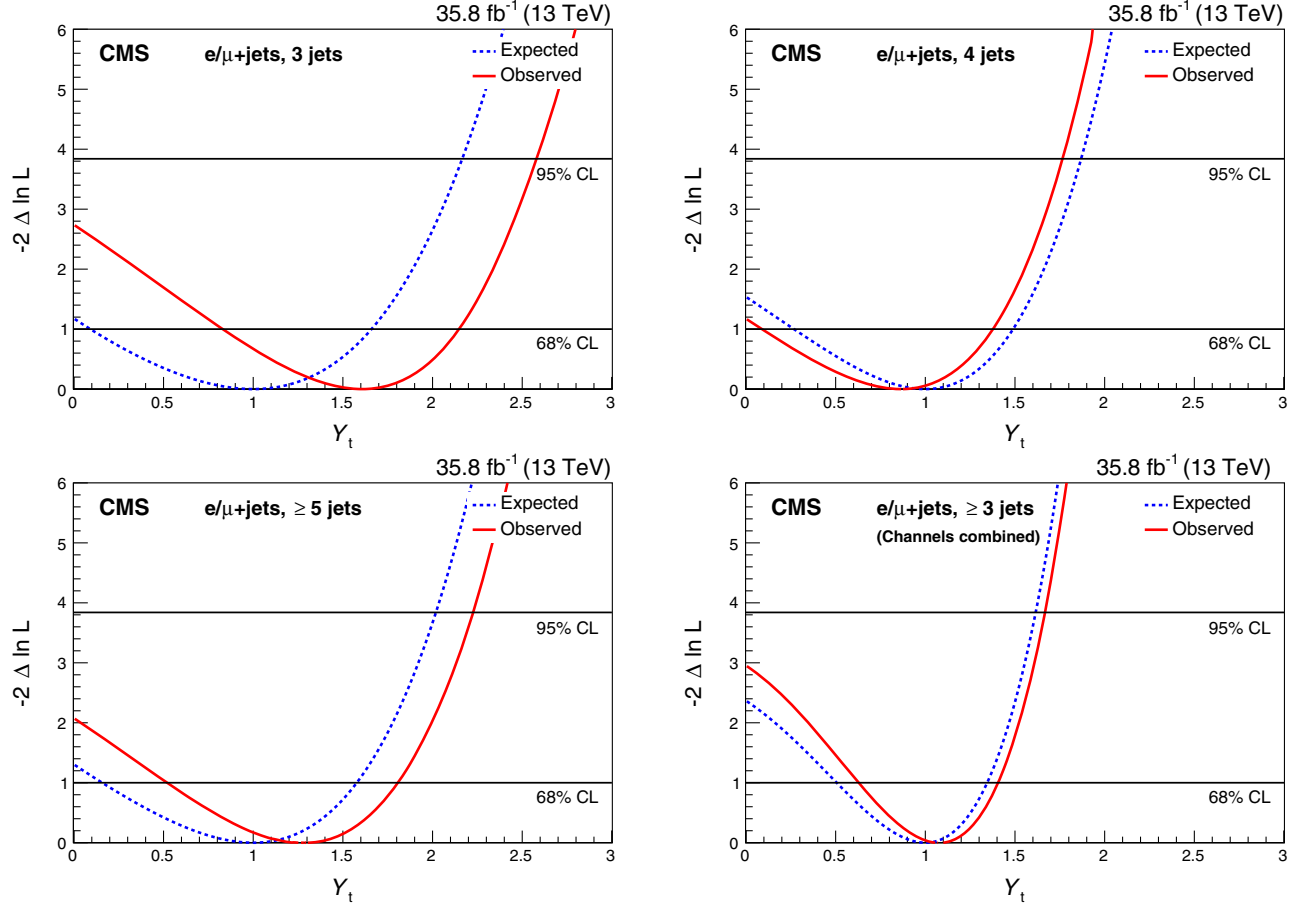

FIG. 11. The test statistic scan vs  $Y_t$  for each channel (three, four, and five or more jets), and all channels combined. The test statistic minimum indicates the best fit of  $Y_t$ . The horizontal lines indicate 68 and 95% CL intervals.

down by their respective experimental uncertainties [61]. The resulting systematic uncertainty is around 3%.

Finally, the weak interaction correction is implemented by reweighting the nominal POWHEG samples with the ratio of the weak correction over the LO cross section calculated by HATHOR. As recommended by the HATHOR authors [9], the associated systematic uncertainty for this procedure can be estimated from the difference between the multiplicative and additive treatments, i.e.,  $(1 + \delta_{\text{QCD}})(1 + \delta_{\text{W}})$  and  $(1 + \delta_{\text{QCD}} + \delta_{\text{W}})$ , where  $\delta_{\text{QCD}}$  is estimated from the effect of varying the factorization and renormalization scale up and down by a factor of two on the NLO cross section, and

$\delta_{\text{W}}$  is the ratio of the weak correction over the LO cross section obtained from HATHOR. The difference is  $\delta_{\text{QCD}}\delta_{\text{W}}$ , which is also a function of  $Y_t$ . This uncertainty is accounted for as a shape nuisance in the likelihood fit.

The experimental uncertainties are treated as 100% correlated among signal and background processes and across the jet multiplicity channels.

## XI. RESULTS

The data events are analyzed in three exclusive channels, according to the number of jets in the final state. The expected signal and background estimation shown in Table I, and the systematic uncertainties described in Sec. X are used to construct a binned likelihood (Eq. (4)) as a product of the Poisson probabilities from all bins in  $(M_{i\bar{i}}, |\Delta y_{i\bar{i}}|)$ . From this, we construct a profile likelihood ratio test statistic  $q(Y_t) = -2\ln[\mathcal{L}(Y_t, \hat{\theta})/\mathcal{L}(\hat{Y}_t, \hat{\theta})]$ , where  $\hat{\theta}$  in the numerator denotes the value of the estimator  $\hat{\theta}$  that maximizes the likelihood for a specific  $Y_t$ , i.e., it is the conditional maximum-likelihood estimator of  $\theta$  (and thus is a function of  $Y_t$ ). The denominator is the maximized (unconditional) likelihood function, i.e.,  $\hat{Y}_t$  and

TABLE III. The expected and observed best fit values and 95% CL upper limits on  $Y_t$ .

Channel	Best fit $Y_t$		95% CL upper limit	
	Expected	Observed	Expected	Observed
3 jets	$1.00^{+0.66}_{-0.90}$	$1.62^{+0.53}_{-0.78}$	<2.17	<2.59
4 jets	$1.00^{+0.50}_{-0.72}$	$0.87^{+0.51}_{-0.77}$	<1.88	<1.77
$\geq 5$ jets	$1.00^{+0.59}_{-0.83}$	$1.27^{+0.55}_{-0.74}$	<2.03	<2.23
Combined	$1.00^{+0.35}_{-0.48}$	$1.07^{+0.34}_{-0.43}$	<1.62	<1.67

$\hat{\theta}$  are the values of the estimators that simultaneously maximize the likelihood. The statistical procedure to extract the parameter of interest is detailed in Ref. [62].

The distributions of  $M_{\bar{t}t}$  and  $|\Delta y_{\bar{t}t}|$  after performing the combined likelihood fit are shown in Fig. 10. The analysis covers the phase space from the production threshold in  $M_{\bar{t}t}$  (which is  $\approx 200$  GeV at the detector level for events with three reconstructed jets) up to 2 TeV.

We measure the top quark Yukawa coupling by scanning the likelihood function with respect to  $Y_t$ . The likelihood scan distributions can be found in Fig. 11. The expected and observed results are presented in Table III. An upper limit on  $Y_t$  is also determined, using a modified frequentist  $\text{CL}_s$  procedure [63,64] with the asymptotic method [65].

## XII. SUMMARY

A measurement of the top quark Yukawa coupling is presented, extracted by investigating  $t\bar{t}$  pair production in final states with an electron or muon and several jets, using proton–proton data collected by the CMS experiment at  $\sqrt{s} = 13$  TeV, corresponding to an integrated luminosity of  $35.8 \text{ fb}^{-1}$ . The  $t\bar{t}$  production cross section is sensitive to the top quark Yukawa coupling through weak force corrections that can modify the distributions of the mass of top quark–antiquark pairs,  $M_{\bar{t}t}$ , and the rapidity difference between top quark and antiquark,  $\Delta y_{\bar{t}t}$ . The kinematic properties of these final states are reconstructed in events with at least three jets, two of which are identified as originating from bottom quarks. The inclusion of events with only three reconstructed jets using a dedicated algorithm improves the sensitivity of the analysis by increasing the signal from events in the low- $M_{\bar{t}t}$  region, which is most sensitive to the Yukawa coupling. The ratio of the top quark Yukawa coupling to its expected SM value,  $Y_t$ , is extracted by comparing the data with the expected  $t\bar{t}$  signal for different values of  $Y_t$  in a total of 55 bins in  $M_{\bar{t}t}$ ,  $|\Delta y_{\bar{t}t}|$ , and the number of reconstructed jets. The measured value of  $Y_t$  is  $1.07^{+0.34}_{-0.43}$ , compared to an expected value of  $1.00^{+0.35}_{-0.48}$ . The observed upper limit on  $Y_t$  is 1.67 at 95% confidence level (CL), with an expected value of 1.62.

Although the method presented in this paper is not as sensitive as the combined CMS measurement of  $Y_t$  performed using Higgs boson production and decays in multiple channels [66], it has the advantage that it does not depend on any assumptions about the couplings of the Higgs boson to particles other than the top quark. The result presented here is more sensitive than the only other result from CMS exclusively dependent on  $Y_t$ , namely the limit on the  $t\bar{t}t\bar{t}$  cross section, which constrains  $Y_t$  to be less than 2.1 at 95% CL [8].

## ACKNOWLEDGMENTS

We congratulate our colleagues in the CERN accelerator departments for the excellent performance of the LHC and

thank the technical and administrative staffs at CERN and at other CMS institutes for their contributions to the success of the CMS effort. In addition, we gratefully acknowledge the computing centers and personnel of the Worldwide LHC Computing Grid for delivering so effectively the computing infrastructure essential to our analyses. Finally, we acknowledge the enduring support for the construction and operation of the LHC and the CMS detector provided by the following funding agencies: BMBWF and FWF (Austria); FNRS and FWO (Belgium); CNPq, CAPES, FAPERJ, FAPERGS, and FAPESP (Brazil); MES (Bulgaria); CERN; CAS, MoST, and NSFC (China); COLCIENCIAS (Colombia); MSES and CSF (Croatia); RPF (Cyprus); SENESCYT (Ecuador); MoER, ERC IUT, PUT and ERDF (Estonia); Academy of Finland, MEC, and HIP (Finland); CEA and CNRS/IN2P3 (France); BMBF, DFG, and HGF (Germany); GSRT (Greece); NKfIA (Hungary); DAE and DST (India); IPM (Iran); SFI (Ireland); INFN (Italy); MSIP and NRF (Republic of Korea); MES (Latvia); LAS (Lithuania); MOE and UM (Malaysia); BUAP, CINVESTAV, CONACYT, LNS, SEP, and UASLP-FAI (Mexico); MOS (Montenegro); MBIE (New Zealand); PAEC (Pakistan); MSHE and NSC (Poland); FCT (Portugal); JINR (Dubna); MON, RosAtom, RAS, RFBR, and NRC KI (Russia); MESTD (Serbia); SEIDI, CPAN, PCTI, and FEDER (Spain); MOSTR (Sri Lanka); Swiss Funding Agencies (Switzerland); MST (Taipei); ThEPCenter, IPST, STAR, and NSTDA (Thailand); TUBITAK and TAEK (Turkey); NASU and SFFR (Ukraine); STFC (United Kingdom); DOE and NSF (USA). Individuals have received support from the Marie-Curie program and the European Research Council and Horizon 2020 Grant, Contracts No. 675440 and No. 765710 (European Union); the Leventis Foundation; the A. P. Sloan Foundation; the Alexander von Humboldt Foundation; the Belgian Federal Science Policy Office; the Fonds pour la Formation à la Recherche dans l'Industrie et dans l'Agriculture (FRIA-Belgium); the Agentschap voor Innovatie door Wetenschap en Technologie (IWT-Belgium); the F. R. S.-FNRS and FWO (Belgium) under the “Excellence of Science—EOS”—be.h Project No. 30820817; the Beijing Municipal Science & Technology Commission, No. Z181100004218003; the Ministry of Education, Youth and Sports (MEYS) of the Czech Republic; the Lendület (“Momentum”) Program and the János Bolyai Research Scholarship of the Hungarian Academy of Sciences, the New National Excellence Program ÚNKP, the NKfIA research Grants No. 123842, No. 123959, No. 124845, No. 124850, No. 125105, No. 128713, No. 128786, and No. 129058 (Hungary); the Council of Science and Industrial Research, India; the HOMING PLUS program of the Foundation for Polish Science, cofinanced from European Union, Regional Development Fund, the Mobility Plus program of the

Ministry of Science and Higher Education, the National Science Center (Poland), Contracts No. Harmonia 2014/14/M/ST2/00428, No. Opus 2014/13/B/ST2/02543, No. 2014/15/B/ST2/03998, and No. 2015/19/B/ST2/02861, No. Sonata-bis 2012/07/E/ST2/01406; the National Priorities Research Program by Qatar National Research Fund; the Programa Estatal de Fomento de la Investigación Científica y Técnica de Excelencia María de Maeztu, Grant

No. MDM-2015-0509 and the Programa Severo Ochoa del Principado de Asturias; the Thalys and Aristeia programs cofinanced by EU-ESF and the Greek NSRF; the Rachadapisek Sompot Fund for Postdoctoral Fellowship, Chulalongkorn University and the Chulalongkorn Academic into Its 2nd Century Project Advancement Project (Thailand); the Welch Foundation, Contract No. C-1845; and the Weston Havens Foundation (USA).

- 
- [1] S. Weinberg, A Model of Leptons, *Phys. Rev. Lett.* **19**, 1264 (1967).
- [2] D. M. Webber *et al.* (MuLan Collaboration), Measurement of the Positive Muon Lifetime and Determination of the Fermi Constant to Part-Per-Million Precision, *Phys. Rev. Lett.* **106**, 041803 (2011); Erratum, *Phys. Rev. Lett.* **106**, 079901(E) (2011).
- [3] CMS Collaboration, Measurement of the top quark mass using proton-proton data at  $\sqrt{s} = 7$  and 8 TeV, *Phys. Rev. D* **93**, 072004 (2016).
- [4] J. R. Andersen *et al.* (LHC Higgs Cross Section Working Group), Handbook of LHC Higgs Cross Sections: 3. Higgs Properties, CERN Reports No. CERN-2013-004, No. FER-MILAB-CONF-13-667-T, No. CERN-2013-004, 2013, <http://dx.doi.org/10.5170/CERN-2013-004>.
- [5] CMS Collaboration, Measurements of properties of the Higgs boson decaying into the four-lepton final state in pp collisions at  $\sqrt{s} = 13$  TeV, *J. High Energy Phys.* **11** (2017) 047.
- [6] CMS Collaboration, Measurements of Higgs boson properties in the diphoton decay channel in proton-proton collisions at  $\sqrt{s} = 13$  TeV, *J. High Energy Phys.* **11** (2018) 185.
- [7] CMS Collaboration, Observation of  $t\bar{t}H$  Production, *Phys. Rev. Lett.* **120**, 231801 (2018).
- [8] CMS Collaboration, Search for Standard Model production of four top quarks with same-sign and multilepton final states in proton-proton collisions at  $\sqrt{s} = 13$  TeV, *Eur. Phys. J. C* **78**, 140 (2018).
- [9] J. H. Kühn, A. Scharf, and P. Uwer, Weak interactions in top-quark pair production at hadron colliders: An update, *Phys. Rev. D* **91**, 014020 (2015).
- [10] CMS Collaboration, Measurement of differential cross sections for top quark pair production using the lepton + jets final state in proton-proton collisions at 13 TeV, *Phys. Rev. D* **95**, 092001 (2017).
- [11] M. J. Strassler and M. E. Peskin, The heavy top quark threshold: QCD and the Higgs, *Phys. Rev. D* **43**, 1500 (1991).
- [12] M. Beneke, A. Maier, J. Piclum, and T. Rauh, Higgs effects in top anti-top production near threshold in  $e^+e^-$  annihilation, *Nucl. Phys.* **B899**, 180 (2015).
- [13] M. Aliev, H. Lacker, U. Langenfeld, S. Moch, P. Uwer, and M. Wiedermann, HATHOR: HAdronic top and heavy quarks cross section calculator, *Comput. Phys. Commun.* **182**, 1034 (2011).
- [14] CMS Collaboration, Measurement of differential cross sections for the production of top quark pairs and of additional jets in lepton + jets events from pp collisions at  $\sqrt{s} = 13$  TeV, *Phys. Rev. D* **97**, 112003 (2018).
- [15] M. Czakon, D. Heymes, A. Mitov, D. Pagani, I. Tsinikos, and M. Zaro, Top-pair production at the LHC through NNLO QCD and NLO EW, *J. High Energy Phys.* **10** (2017) 186.
- [16] M. L. Czakon, A. Ferroglia, A. Mitov, D. Pagani, A. S. Papanastasiou, B. D. Pecjak, D. J. Scott, I. Tsinikos, X. Wang, L. L. Yang, and M. Zaro, Top quark pair production at NNLO + NNLL' in QCD combined with electroweak corrections, in *11th International Workshop on Top Quark Physics (TOP2018) Bad Neuenahr, Germany, 2018* (2019) [arXiv:1901.08281].
- [17] W. Hollik and M. Kollar, NLO QED contributions to top-pair production at hadron collider, *Phys. Rev. D* **77**, 014008 (2008).
- [18] W. Beenakker, A. Denner, W. Hollik, R. Mertig, T. Sack, and D. Wackerroth, Electroweak one loop contributions to top pair production in hadron colliders, *Nucl. Phys.* **B411**, 343 (1994).
- [19] P. Nason, A new method for combining NLO QCD with shower Monte Carlo algorithms, *J. High Energy Phys.* **11** (2004) 040.
- [20] S. Frixione, P. Nason, and C. Oleari, Matching NLO QCD computations with parton shower simulations: The POWHEG method, *J. High Energy Phys.* **11** (2007) 070.
- [21] S. Alioli, P. Nason, C. Oleari, and E. Re, A general framework for implementing NLO calculations in shower Monte Carlo programs: The POWHEG BOX, *J. High Energy Phys.* **06** (2010) 043.
- [22] J. M. Campbell, R. K. Ellis, P. Nason, and E. Re, Top-pair production and decay at NLO matched with parton showers, *J. High Energy Phys.* **04** (2015) 114.
- [23] CMS Collaboration, The CMS experiment at the CERN LHC, *J. Instrum.* **3**, S08004 (2008).
- [24] CMS Collaboration, Particle-flow reconstruction and global event description with the CMS detector, *J. Instrum.* **12**, P10003 (2017).
- [25] CMS Collaboration, The CMS trigger system, *J. Instrum.* **12**, P01020 (2017).
- [26] T. Sjöstrand, S. Ask, J. R. Christiansen, R. Corke, N. Desai, P. Ilten, S. Mrenna, S. Prestel, C. O. Rasmussen, and



- P.Z. Skands, An introduction to PYTHIA 8.2, *Comput. Phys. Commun.* **191**, 159 (2015).
- [27] P. Skands, S. Carrazza, and J. Rojo, Tuning PYTHIA 8.1: The Monash 2013 tune, *Eur. Phys. J. C* **74**, 3024 (2014).
- [28] R. D. Ball *et al.* (NNPDF Collaboration), Parton distributions for the LHC Run II, *J. High Energy Phys.* **04** (2015) 040.
- [29] M. Czakon and A. Mitov, Top++: A program for the calculation of the top-pair cross-section at hadron colliders, *Comput. Phys. Commun.* **185**, 2930 (2014).
- [30] J. Alwall, R. Frederix, S. Frixione, V. Hirschi, F. Maltoni, O. Mattelaer, H. S. Shao, T. Stelzer, P. Torrielli, and M. Zaro, The automated computation of tree-level and next-to-leading order differential cross sections, and their matching to parton shower simulations, *J. High Energy Phys.* **07** (2014) 079.
- [31] Y. Li and F. Petriello, Combining QCD and electroweak corrections to dilepton production in FEWZ, *Phys. Rev. D* **86**, 094034 (2012).
- [32] P. Kant, O. M. Kind, T. Kintscher, T. Lohse, T. Martini, S. Mölbitz, P. Rieck, and P. Uwer, HATHOR for single top-quark production: Updated predictions and uncertainty estimates for single top-quark production in hadronic collisions, *Comput. Phys. Commun.* **191**, 74 (2015).
- [33] N. Kidonakis, NNLL threshold resummation for top-pair and single-top production, *Phys. Part. Nucl.* **45**, 714 (2014).
- [34] S. Agostinelli *et al.* (GEANT4 Collaboration), GEANT4—a simulation toolkit, *Nucl. Instrum. Methods Phys. Res., Sect. A* **506**, 250 (2003).
- [35] M. Cacciari, G. P. Salam, and G. Soyez, The anti- $k_T$  jet clustering algorithm, *J. High Energy Phys.* **04** (2008) 063.
- [36] M. Cacciari, G. P. Salam, and G. Soyez, FastJet user manual, *Eur. Phys. J. C* **72**, 1896 (2012).
- [37] CMS Collaboration, Determination of jet energy calibration and transverse momentum resolution in CMS, *J. Instrum.* **6**, P11002 (2011).
- [38] CMS Collaboration, Jet energy scale and resolution in the CMS experiment in pp collisions at 8 TeV, *J. Instrum.* **12**, P02014 (2017).
- [39] CMS Collaboration, Jet performance in pp collisions at  $\sqrt{s} = 7$  TeV, CMS physics analysis summary, Report No. CMS-PAS-JME-10-003, 2010.
- [40] CMS Collaboration, Identification of heavy-flavour jets with the CMS detector in pp collisions at 13 TeV, *J. Instrum.* **13**, P05011 (2018).
- [41] CMS Collaboration, Measurement of Inclusive W and Z Boson Production Cross Sections in pp Collisions at  $\sqrt{s} = 8$  TeV, *Phys. Rev. Lett.* **112**, 191802 (2014).
- [42] CMS Collaboration, Performance of CMS muon reconstruction in pp collision events at  $\sqrt{s} = 7$  TeV, *J. Instrum.* **7**, P10002 (2012).
- [43] CMS Collaboration, Performance of electron reconstruction and selection with the CMS detector in proton-proton collisions at  $\sqrt{s} = 8$  TeV, *J. Instrum.* **10**, P06005 (2015).
- [44] B. A. Betchart, R. Demina, and A. Harel, Analytic solutions for neutrino momenta in decay of top quarks, *Nucl. Instrum. Methods Phys. Res., Sect. A* **736**, 169 (2014).
- [45] R. Demina, A. Harel, and D. Orbaker, Reconstructing  $t\bar{t}$  events with one lost jet, *Nucl. Instrum. Methods Phys. Res., Sect. A* **788**, 128 (2015).
- [46] ATLAS Collaboration, Measurements of top-quark pair differential cross-sections in the lepton + jets channel in pp collisions at  $\sqrt{s} = 8$  TeV using the ATLAS detector, *Eur. Phys. J. C* **76**, 538 (2016).
- [47] CMS Collaboration, Measurement of the differential cross section for top quark pair production in pp collisions at  $\sqrt{s} = 8$  TeV, *Eur. Phys. J. C* **75**, 542 (2015).
- [48] ATLAS Collaboration, Measurements of top-quark pair differential cross-sections in the lepton + jets channel in pp collisions at  $\sqrt{s} = 13$  TeV using the ATLAS detector, *J. High Energy Phys.* **11** (2017) 191.
- [49] M. Czakon, D. Heymes, and A. Mitov, High-Precision Differential Predictions for Top-Quark Pairs at the LHC, *Phys. Rev. Lett.* **116**, 082003 (2016).
- [50] S. Catani, S. Devoto, M. Grazzini, S. Kallweit, and J. Mazzielli, Top-quark pair production at the LHC: Fully differential QCD predictions at NNLO, *J. High Energy Phys.* **07** (2019) 100.
- [51] ATLAS and CMS Collaborations and LHC Higgs Combination Group, Procedure for the LHC Higgs boson search combination in Summer 2011, Technical Reports No. CMS-NOTE-2011-005 and No. ATL-PHYS-PUB-2011-11, 2011.
- [52] CMS Collaboration, CMS luminosity measurement for the 2016 data taking period, CMS physics analysis summary, Report No. CMS-PAS-LUM-17-001, 2017, <http://cds.cern.ch/record/2257069>.
- [53] CMS Collaboration, Measurement of the inelastic proton-proton cross section at  $\sqrt{s} = 13$  TeV, *J. High Energy Phys.* **07** (2018) 161.
- [54] CMS Collaboration, Performance of the CMS muon detector and muon reconstruction with proton-proton collisions at  $\sqrt{s} = 13$  TeV, *J. Instrum.* **13**, P06015 (2018).
- [55] CMS Collaboration, Measurement of the single top quark and antiquark production cross sections in the  $t$  channel and their ratio in proton-proton collisions at  $\sqrt{s} = 13$  TeV, [arXiv:1812.10514](https://arxiv.org/abs/1812.10514).
- [56] CMS Collaboration, Evidence for the Associated Production of a Single Top Quark and a Photon in Proton-Proton Collisions at  $\sqrt{s} = 13$  TeV, *Phys. Rev. Lett.* **121**, 221802 (2018).
- [57] CMS Collaboration, Measurement of the production cross section of a W boson in association with two b jets in pp collisions at  $\sqrt{s} = 8$  TeV, *Eur. Phys. J. C* **77**, 92 (2017).
- [58] ATLAS Collaboration, Measurement of the top quark mass in the  $t\bar{t} \rightarrow$  lepton + jets channel from  $\sqrt{s} = 8$  TeV ATLAS data and combination with previous results, *Eur. Phys. J. C* **79**, 290 (2019).
- [59] M. Czakon, D. Heymes, and A. Mitov, fastNLO tables for NNLO top-quark pair differential distributions, [arXiv:1704.08551](https://arxiv.org/abs/1704.08551).
- [60] CMS Collaboration, Investigations of the impact of the parton shower tuning in Pythia 8 in the modelling of  $t\bar{t}$  at  $\sqrt{s} = 8$  and 13 TeV, CMS physics analysis summary, Report No. CMS-PAS-TOP-16-021, 2016, <https://cds.cern.ch/record/2235192>.
- [61] M. Tanabashi *et al.* (Particle Data Group), Review of particle physics, *Phys. Rev. D* **98**, 030001 (2018).
- [62] J. S. Conway, Incorporating nuisance parameters in likelihoods for multisource spectra, in *Proceedings of the PHYSTAT 2011 Workshop on statistical issues related to discovery claims in search experiments and unfolding*,

- CERN, Geneva, Switzerland, 2011 (CERN, Geneva, 2011), p. 115, <http://dx.doi.org/10.5170/CERN-2011-006.115>.
- [63] T. Junk, Confidence level computation for combining searches with small statistics, *Nucl. Instrum. Methods Phys. Res., Sect. A* **434**, 435 (1999).
- [64] A. L. Read, Presentation of search results: The CL<sub>s</sub> technique, *J. Phys. G* **28**, 2693 (2002).
- [65] G. Cowan, K. Cranmer, E. Gross, and O. Vitells, Asymptotic formulae for likelihood-based tests of new physics, *Eur. Phys. J. C* **71**, 1554 (2011); Erratum, *Eur. Phys. J. C* **73**, 2501(E) (2013).
- [66] CMS Collaboration, Combined measurements of Higgs boson couplings in proton-proton collisions at  $\sqrt{s}=13\text{TeV}$ , *Eur. Phys. J. C* **79**, 421 (2019).

A. M. Sirunyan,<sup>1,a</sup> A. Tumasyan,<sup>1</sup> W. Adam,<sup>2</sup> F. Ambrogio,<sup>2</sup> T. Bergauer,<sup>2</sup> J. Brandstetter,<sup>2</sup> M. Dragicevic,<sup>2</sup> J. Erö,<sup>2</sup> A. Escalante Del Valle,<sup>2</sup> M. Flechl,<sup>2</sup> R. Frühwirth,<sup>2,b</sup> M. Jeitler,<sup>2,b</sup> N. Krammer,<sup>2</sup> I. Krätschmer,<sup>2</sup> D. Liko,<sup>2</sup> T. Madlener,<sup>2</sup> I. Mikulec,<sup>2</sup> N. Rad,<sup>2</sup> J. Schieck,<sup>2,b</sup> R. Schöfbeck,<sup>2</sup> M. Spanring,<sup>2</sup> D. Spitzbart,<sup>2</sup> W. Waltenberger,<sup>2</sup> J. Wittmann,<sup>2</sup> C.-E. Wulz,<sup>2,b</sup> M. Zarucki,<sup>2</sup> V. Drugakov,<sup>3</sup> V. Mossolov,<sup>3</sup> J. Suarez Gonzalez,<sup>3</sup> M. R. Darwish,<sup>4</sup> E. A. De Wolf,<sup>4</sup> D. Di Croce,<sup>4</sup> X. Janssen,<sup>4</sup> J. Lauwers,<sup>4</sup> A. Lelek,<sup>4</sup> M. Pieters,<sup>4</sup> H. Rejeb Sfar,<sup>4</sup> H. Van Haevermaet,<sup>4</sup> P. Van Mechelen,<sup>4</sup> S. Van Putte,<sup>4</sup> N. Van Remortel,<sup>4</sup> F. Blekman,<sup>5</sup> E. S. Bols,<sup>5</sup> S. S. Chhibra,<sup>5</sup> J. D'Hondt,<sup>5</sup> J. De Clercq,<sup>5</sup> D. Lontkovskiy,<sup>5</sup> S. Lowette,<sup>5</sup> I. Marchesini,<sup>5</sup> S. Moortgat,<sup>5</sup> L. Moreels,<sup>5</sup> Q. Python,<sup>5</sup> K. Skovpen,<sup>5</sup> S. Tavernier,<sup>5</sup> W. Van Doninck,<sup>5</sup> P. Van Mulders,<sup>5</sup> I. Van Parijs,<sup>5</sup> D. Beghin,<sup>6</sup> B. Bilin,<sup>6</sup> H. Brun,<sup>6</sup> B. Clerbaux,<sup>6</sup> G. De Lentdecker,<sup>6</sup> H. Delannoy,<sup>6</sup> B. Dorney,<sup>6</sup> L. Favart,<sup>6</sup> A. Grebenyuk,<sup>6</sup> A. K. Kalsi,<sup>6</sup> J. Luetic,<sup>6</sup> A. Popov,<sup>6</sup> N. Postiau,<sup>6</sup> E. Starling,<sup>6</sup> L. Thomas,<sup>6</sup> C. Vander Velde,<sup>6</sup> P. Vanlaer,<sup>6</sup> D. Vannerom,<sup>6</sup> Q. Wang,<sup>6</sup> T. Cornelis,<sup>7</sup> D. Dobur,<sup>7</sup> I. Khvastunov,<sup>7,c</sup> C. Roskas,<sup>7</sup> D. Trocino,<sup>7</sup> M. Tytgat,<sup>7</sup> W. Verbeke,<sup>7</sup> B. Vermassen,<sup>7</sup> M. Vit,<sup>7</sup> N. Zaganidis,<sup>7</sup> O. Bondu,<sup>8</sup> G. Bruno,<sup>8</sup> C. Caputo,<sup>8</sup> P. David,<sup>8</sup> C. Delaere,<sup>8</sup> M. Delcourt,<sup>8</sup> A. Giammanco,<sup>8</sup> V. Lemaître,<sup>8</sup> A. Magitteri,<sup>8</sup> J. Prisciandaro,<sup>8</sup> A. Saggio,<sup>8</sup> M. Vidal Marono,<sup>8</sup> P. Vischia,<sup>8</sup> J. Zobec,<sup>8</sup> F. L. Alves,<sup>9</sup> G. A. Alves,<sup>9</sup> G. Correia Silva,<sup>9</sup> C. Hensel,<sup>9</sup> A. Moraes,<sup>9</sup> P. Rebello Teles,<sup>9</sup> E. Belchior Batista Das Chagas,<sup>10</sup> W. Carvalho,<sup>10</sup> J. Chinellato,<sup>10,d</sup> E. Coelho,<sup>10</sup> E. M. Da Costa,<sup>10</sup> G. G. Da Silveira,<sup>10,e</sup> D. De Jesus Damiao,<sup>10</sup> C. De Oliveira Martins,<sup>10</sup> S. Fonseca De Souza,<sup>10</sup> L. M. Huertas Guativa,<sup>10</sup> H. Malbouissou,<sup>10</sup> J. Martins,<sup>10,f</sup> D. Matos Figueiredo,<sup>10</sup> M. Medina Jaime,<sup>10,g</sup> M. Melo De Almeida,<sup>10</sup> C. Mora Herrera,<sup>10</sup> L. Mundim,<sup>10</sup> H. Nogima,<sup>10</sup> W. L. Prado Da Silva,<sup>10</sup> L. J. Sanchez Rosas,<sup>10</sup> A. Santoro,<sup>10</sup> A. Sznajder,<sup>10</sup> M. Thiel,<sup>10</sup> E. J. Tonelli Manganote,<sup>10,d</sup> F. Torres Da Silva De Araujo,<sup>10</sup> A. Vilela Pereira,<sup>10</sup> S. Ahuja,<sup>11a</sup> C. A. Bernardes,<sup>11a</sup> L. Calligaris,<sup>11a</sup> T. R. Fernandez Perez Tomei,<sup>11a</sup> E. M. Gregores,<sup>11a,11b</sup> D. S. Lemos,<sup>11a</sup> P. G. Mercadante,<sup>11a,11b</sup> S. F. Novaes,<sup>11a</sup> Sandra S. Padula,<sup>11a</sup> A. Aleksandrov,<sup>12</sup> G. Antchev,<sup>12</sup> R. Hadjiiska,<sup>12</sup> P. Iaydjiev,<sup>12</sup> A. Marinov,<sup>12</sup> M. Misheva,<sup>12</sup> M. Rodozov,<sup>12</sup> M. Shopova,<sup>12</sup> G. Sultanov,<sup>12</sup> A. Dimitrov,<sup>13</sup> L. Litov,<sup>13</sup> B. Pavlov,<sup>13</sup> P. Petkov,<sup>13</sup> W. Fang,<sup>14,h</sup> X. Gao,<sup>14,h</sup> L. Yuan,<sup>14</sup> M. Ahmad,<sup>15</sup> G. M. Chen,<sup>15</sup> H. S. Chen,<sup>15</sup> M. Chen,<sup>15</sup> C. H. Jiang,<sup>15</sup> D. Leggat,<sup>15</sup> H. Liao,<sup>15</sup> Z. Liu,<sup>15</sup> S. M. Shaheen,<sup>15,i</sup> A. Spiezia,<sup>15</sup> J. Tao,<sup>15</sup> E. Yazgan,<sup>15</sup> H. Zhang,<sup>15</sup> S. Zhang,<sup>15,i</sup> J. Zhao,<sup>15</sup> A. Agapitos,<sup>16</sup> Y. Ban,<sup>16</sup> G. Chen,<sup>16</sup> A. Levin,<sup>16</sup> J. Li,<sup>16</sup> L. Li,<sup>16</sup> Q. Li,<sup>16</sup> Y. Mao,<sup>16</sup> S. J. Qian,<sup>16</sup> D. Wang,<sup>16</sup> Z. Hu,<sup>17</sup> Y. Wang,<sup>17</sup> C. Avila,<sup>18</sup> A. Cabrera,<sup>18</sup> L. F. Chaparro Sierra,<sup>18</sup> C. Florez,<sup>18</sup> C. F. González Hernández,<sup>18</sup> M. A. Segura Delgado,<sup>18</sup> J. Mejia Guisao,<sup>19</sup> J. D. Ruiz Alvarez,<sup>19</sup> C. A. Salazar González,<sup>19</sup> N. Vanegas Arbelaez,<sup>19</sup> D. Giljanović,<sup>20</sup> N. Godinovic,<sup>20</sup> D. Lelas,<sup>20</sup> I. Puljak,<sup>20</sup> T. Sculac,<sup>20</sup> Z. Antunovic,<sup>21</sup> M. Kovac,<sup>21</sup> V. Brigljevic,<sup>22</sup> S. Ceci,<sup>22</sup> D. Ferencek,<sup>22</sup> K. Kadija,<sup>22</sup> B. Mesic,<sup>22</sup> M. Roguljic,<sup>22</sup> A. Starodumov,<sup>22,j</sup> T. Susa,<sup>22</sup> M. W. Ather,<sup>23</sup> A. Attikis,<sup>23</sup> E. Erodotou,<sup>23</sup> A. Ioannou,<sup>23</sup> M. Kolosova,<sup>23</sup> S. Konstantinou,<sup>23</sup> G. Mavromanolakis,<sup>23</sup> J. Mousa,<sup>23</sup> C. Nicolaou,<sup>23</sup> F. Ptochos,<sup>23</sup> P. A. Razis,<sup>23</sup> H. Rykaczewski,<sup>23</sup> D. Tsiakkouri,<sup>23</sup> M. Finger,<sup>24,k</sup> M. Finger Jr.,<sup>24,k</sup> A. Kveton,<sup>24</sup> J. Tomsa,<sup>24</sup> E. Ayala,<sup>25</sup> E. Carrera Jarrin,<sup>26</sup> H. Abdalla,<sup>27,1</sup> A. A. Abdelalim,<sup>27,m,n</sup> S. Bhowmik,<sup>28</sup> A. Carvalho Antunes De Oliveira,<sup>28</sup> R. K. Dewanjee,<sup>28</sup> K. Ehataht,<sup>28</sup> M. Kadastik,<sup>28</sup> M. Raidal,<sup>28</sup> C. Veelken,<sup>28</sup> P. Eerola,<sup>29</sup> L. Forthomme,<sup>29</sup> H. Kirschenmann,<sup>29</sup> K. Osterberg,<sup>29</sup> M. Voutilainen,<sup>29</sup> F. Garcia,<sup>30</sup> J. Havukainen,<sup>30</sup> J. K. Heikkilä,<sup>30</sup> T. Järvinen,<sup>30</sup> V. Karimäki,<sup>30</sup> R. Kinnunen,<sup>30</sup> T. Lampén,<sup>30</sup> K. Lassila-Perini,<sup>30</sup> S. Laurila,<sup>30</sup> S. Lehti,<sup>30</sup> T. Lindén,<sup>30</sup> P. Luukka,<sup>30</sup> T. Mäenpää,<sup>30</sup> H. Siikonen,<sup>30</sup> E. Tuominen,<sup>30</sup> J. Tuominiemi,<sup>30</sup> T. Tuuva,<sup>31</sup> M. Besancon,<sup>32</sup> F. Couderc,<sup>32</sup> M. Dejardin,<sup>32</sup> D. Denegri,<sup>32</sup> B. Fabbro,<sup>32</sup> J. L. Faure,<sup>32</sup> F. Ferri,<sup>32</sup> S. Ganjour,<sup>32</sup> A. Givernaud,<sup>32</sup> P. Gras,<sup>32</sup> G. Hamel de Monchenault,<sup>32</sup> P. Jarry,<sup>32</sup> C. Leloup,<sup>32</sup> E. Locci,<sup>32</sup> J. Malcles,<sup>32</sup> J. Rander,<sup>32</sup> A. Rosowsky,<sup>32</sup> M. Ö. Sahin,<sup>32</sup> A. Savoy-Navarro,<sup>32,o</sup> M. Titov,<sup>32</sup> C. Amendola,<sup>33</sup> F. Beaudette,<sup>33</sup> P. Busson,<sup>33</sup> C. Charlot,<sup>33</sup> B. Diab,<sup>33</sup> R. Granier de Cassagnac,<sup>33</sup> I. Kucher,<sup>33</sup> A. Lobanov,<sup>33</sup> C. Martin Perez,<sup>33</sup> M. Nguyen,<sup>33</sup> C. Ochando,<sup>33</sup> P. Paganini,<sup>33</sup> J. Rembser,<sup>33</sup> R. Salerno,<sup>33</sup> J. B. Sauvan,<sup>33</sup> Y. Sirois,<sup>33</sup> A. Zabi,<sup>33</sup> A. Zghiche,<sup>33</sup> J.-L. Agram,<sup>34,p</sup> J. Andrea,<sup>34</sup> D. Bloch,<sup>34</sup> G. Bourgatte,<sup>34</sup> J.-M. Brom,<sup>34</sup> E. C. Chabert,<sup>34</sup> C. Collard,<sup>34</sup> E. Conte,<sup>34,p</sup> J.-C. Fontaine,<sup>34,p</sup> D. Gelé,<sup>34</sup>

U. Goerlach,<sup>34</sup> M. Jansová,<sup>34</sup> A.-C. Le Bihan,<sup>34</sup> N. Tonon,<sup>34</sup> P. Van Hove,<sup>34</sup> S. Gadrat,<sup>35</sup> S. Beauceron,<sup>36</sup> C. Bernet,<sup>36</sup> G. Boudoul,<sup>36</sup> C. Camen,<sup>36</sup> N. Chanon,<sup>36</sup> R. Chierici,<sup>36</sup> D. Contardo,<sup>36</sup> P. Depasse,<sup>36</sup> H. El Mamouni,<sup>36</sup> J. Fay,<sup>36</sup> S. Gascon,<sup>36</sup> M. Gouzevitch,<sup>36</sup> B. Ille,<sup>36</sup> Sa. Jain,<sup>36</sup> F. Lagarde,<sup>36</sup> I. B. Laktineh,<sup>36</sup> H. Lattaud,<sup>36</sup> M. Lethuillier,<sup>36</sup> L. Mirabito,<sup>36</sup> S. Perries,<sup>36</sup> V. Sordini,<sup>36</sup> G. Touquet,<sup>36</sup> M. Vander Donckt,<sup>36</sup> S. Viret,<sup>36</sup> T. Toriashvili,<sup>37,q</sup> Z. Tsamalaidze,<sup>38,k</sup> C. Autermann,<sup>39</sup> L. Feld,<sup>39</sup> M. K. Kiesel,<sup>39</sup> K. Klein,<sup>39</sup> M. Lipinski,<sup>39</sup> D. Meuser,<sup>39</sup> A. Pauls,<sup>39</sup> M. Preuten,<sup>39</sup> M. P. Rauch,<sup>39</sup> C. Schomakers,<sup>39</sup> J. Schulz,<sup>39</sup> M. Teroerde,<sup>39</sup> B. Wittmer,<sup>39</sup> A. Albert,<sup>40</sup> M. Erdmann,<sup>40</sup> S. Erdweg,<sup>40</sup> T. Esch,<sup>40</sup> B. Fischer,<sup>40</sup> R. Fischer,<sup>40</sup> S. Ghosh,<sup>40</sup> T. Hebbeker,<sup>40</sup> K. Hoepfner,<sup>40</sup> H. Keller,<sup>40</sup> L. Mastrolorenzo,<sup>40</sup> M. Merschmeyer,<sup>40</sup> A. Meyer,<sup>40</sup> P. Millet,<sup>40</sup> G. Mocellin,<sup>40</sup> S. Mondal,<sup>40</sup> S. Mukherjee,<sup>40</sup> D. Noll,<sup>40</sup> A. Novak,<sup>40</sup> T. Pook,<sup>40</sup> A. Pozdnyakov,<sup>40</sup> T. Quast,<sup>40</sup> M. Radziej,<sup>40</sup> Y. Rath,<sup>40</sup> H. Reithler,<sup>40</sup> M. Rieger,<sup>40</sup> A. Schmidt,<sup>40</sup> S. C. Schuler,<sup>40</sup> A. Sharma,<sup>40</sup> S. Thüer,<sup>40</sup> S. Wiedenbeck,<sup>40</sup> G. Flügge,<sup>41</sup> W. Haj Ahmad,<sup>41,r</sup> O. Hlushchenko,<sup>41</sup> T. Kress,<sup>41</sup> T. Müller,<sup>41</sup> A. Nehr Korn,<sup>41</sup> A. Nowack,<sup>41</sup> C. Pistone,<sup>41</sup> O. Pooth,<sup>41</sup> D. Roy,<sup>41</sup> H. Sert,<sup>41</sup> A. Stahl,<sup>41,s</sup> M. Aldaya Martin,<sup>42</sup> C. Asawatangtrakuldee,<sup>42</sup> P. Asmuss,<sup>42</sup> I. Babounikau,<sup>42</sup> H. Bakhshiansohi,<sup>42</sup> K. Beernaert,<sup>42</sup> O. Behnke,<sup>42</sup> U. Behrens,<sup>42</sup> A. Bermúdez Martínez,<sup>42</sup> D. Bertsche,<sup>42</sup> A. A. Bin Anuar,<sup>42</sup> K. Borras,<sup>42,t</sup> V. Botta,<sup>42</sup> A. Campbell,<sup>42</sup> A. Cardini,<sup>42</sup> P. Connor,<sup>42</sup> S. Consuegra Rodríguez,<sup>42</sup> C. Contreras-Campana,<sup>42</sup> V. Danilov,<sup>42</sup> A. De Wit,<sup>42</sup> M. M. Defranchis,<sup>42</sup> C. Diez Pardos,<sup>42</sup> D. Domínguez Damiani,<sup>42</sup> G. Eckerlin,<sup>42</sup> D. Eckstein,<sup>42</sup> T. Eichhorn,<sup>42</sup> A. Elwood,<sup>42</sup> E. Eren,<sup>42</sup> E. Gallo,<sup>42,u</sup> A. Geiser,<sup>42</sup> J. M. Grados Luyando,<sup>42</sup> A. Grohsjean,<sup>42</sup> M. Guthoff,<sup>42</sup> M. Haranko,<sup>42</sup> A. Harb,<sup>42</sup> A. Jafari,<sup>42</sup> N. Z. Jomhari,<sup>42</sup> H. Jung,<sup>42</sup> A. Kasem,<sup>42,i</sup> M. Kasemann,<sup>42</sup> H. Kaveh,<sup>42</sup> J. Keaveney,<sup>42</sup> C. Kleinwort,<sup>42</sup> J. Knolle,<sup>42</sup> D. Krücker,<sup>42</sup> W. Lange,<sup>42</sup> T. Lenz,<sup>42</sup> J. Leonard,<sup>42</sup> J. Lidrych,<sup>42</sup> K. Lipka,<sup>42</sup> W. Lohmann,<sup>42,v</sup> R. Mankel,<sup>42</sup> I.-A. Melzer-Pellmann,<sup>42</sup> A. B. Meyer,<sup>42</sup> M. Meyer,<sup>42</sup> M. Missiroli,<sup>42</sup> G. Mittag,<sup>42</sup> J. Mnich,<sup>42</sup> A. Mussgiller,<sup>42</sup> V. Myronenko,<sup>42</sup> D. Pérez Adán,<sup>42</sup> S. K. Pflitsch,<sup>42</sup> D. Pitzl,<sup>42</sup> A. Raspereza,<sup>42</sup> A. Saibel,<sup>42</sup> M. Savitskiy,<sup>42</sup> V. Scheurer,<sup>42</sup> P. Schütze,<sup>42</sup> C. Schwanenberger,<sup>42</sup> R. Shevchenko,<sup>42</sup> A. Singh,<sup>42</sup> H. Tholen,<sup>42</sup> O. Turkot,<sup>42</sup> A. Vagnerini,<sup>42</sup> M. Van De Klundert,<sup>42</sup> G. P. Van Onsem,<sup>42</sup> R. Walsh,<sup>42</sup> Y. Wen,<sup>42</sup> K. Wichmann,<sup>42</sup> C. Wissing,<sup>42</sup> O. Zenaiev,<sup>42</sup> R. Zlebick,<sup>42</sup> R. Aggleton,<sup>43</sup> S. Bein,<sup>43</sup> L. Benato,<sup>43</sup> A. Benecke,<sup>43</sup> V. Blobel,<sup>43</sup> T. Dreyer,<sup>43</sup> A. Ebrahimi,<sup>43</sup> A. Fröhlich,<sup>43</sup> C. Garbers,<sup>43</sup> E. Garutti,<sup>43</sup> D. Gonzalez,<sup>43</sup> P. Gunnellini,<sup>43</sup> J. Haller,<sup>43</sup> A. Hinemann,<sup>43</sup> A. Karavdina,<sup>43</sup> G. Kasieczka,<sup>43</sup> R. Klanner,<sup>43</sup> R. Kogler,<sup>43</sup> N. Kovalchuk,<sup>43</sup> S. Kurz,<sup>43</sup> V. Kutzner,<sup>43</sup> J. Lange,<sup>43</sup> T. Lange,<sup>43</sup> A. Malara,<sup>43</sup> D. Marconi,<sup>43</sup> J. Multhaupt,<sup>43</sup> M. Niedziela,<sup>43</sup> C. E. N. Niemeyer,<sup>43</sup> D. Nowatschin,<sup>43</sup> A. Perieanu,<sup>43</sup> A. Reimers,<sup>43</sup> O. Rieger,<sup>43</sup> C. Scharf,<sup>43</sup> P. Schleper,<sup>43</sup> S. Schumann,<sup>43</sup> J. Schwandt,<sup>43</sup> J. Sonneveld,<sup>43</sup> H. Stadie,<sup>43</sup> G. Steinbrück,<sup>43</sup> F. M. Stober,<sup>43</sup> M. Stöver,<sup>43</sup> B. Vormwald,<sup>43</sup> I. Zoi,<sup>43</sup> M. Akbiyik,<sup>44</sup> C. Barth,<sup>44</sup> M. Baselga,<sup>44</sup> S. Baur,<sup>44</sup> T. Berger,<sup>44</sup> E. Butz,<sup>44</sup> R. Caspart,<sup>44</sup> T. Chwalek,<sup>44</sup> W. De Boer,<sup>44</sup> A. Dierlamm,<sup>44</sup> K. El Morabit,<sup>44</sup> N. Faltermann,<sup>44</sup> M. Giffels,<sup>44</sup> P. Goldenzweig,<sup>44</sup> A. Gottmann,<sup>44</sup> M. A. Harrendorf,<sup>44</sup> F. Hartmann,<sup>44,s</sup> U. Husemann,<sup>44</sup> S. Kudella,<sup>44</sup> S. Mitra,<sup>44</sup> M. U. Mozer,<sup>44</sup> Th. Müller,<sup>44</sup> M. Musich,<sup>44</sup> A. Nürnberg,<sup>44</sup> G. Quast,<sup>44</sup> K. Rabbertz,<sup>44</sup> M. Schröder,<sup>44</sup> I. Shvetsov,<sup>44</sup> H. J. Simonis,<sup>44</sup> R. Ulrich,<sup>44</sup> M. Weber,<sup>44</sup> C. Wöhrmann,<sup>44</sup> R. Wolf,<sup>44</sup> G. Anagnostou,<sup>45</sup> P. Asenov,<sup>45</sup> G. Daskalakis,<sup>45</sup> T. Gerasis,<sup>45</sup> A. Kyriakis,<sup>45</sup> D. Loukas,<sup>45</sup> G. Paspalaki,<sup>45</sup> M. Diamantopoulou,<sup>46</sup> G. Karathanasis,<sup>46</sup> P. Kontaxakis,<sup>46</sup> A. Panagiotou,<sup>46</sup> I. Papavergou,<sup>46</sup> N. Saoulidou,<sup>46</sup> A. Stakia,<sup>46</sup> K. Theofilatos,<sup>46</sup> K. Vellidis,<sup>46</sup> G. Bakas,<sup>47</sup> K. Kousouris,<sup>47</sup> I. Papakrivopoulos,<sup>47</sup> G. Tsipolitis,<sup>47</sup> I. Evangelou,<sup>48</sup> C. Foudas,<sup>48</sup> P. Gianneios,<sup>48</sup> P. Katsoulis,<sup>48</sup> P. Kokkas,<sup>48</sup> S. Mallios,<sup>48</sup> K. Manitaras,<sup>48</sup> N. Manthos,<sup>48</sup> I. Papadopoulos,<sup>48</sup> J. Strolagos,<sup>48</sup> F. A. Triantis,<sup>48</sup> D. Tsitsonis,<sup>48</sup> M. Bartók,<sup>49,w</sup> M. Csanad,<sup>49</sup> P. Major,<sup>49</sup> K. Mandal,<sup>49</sup> A. Mehta,<sup>49</sup> M. I. Nagy,<sup>49</sup> G. Pasztor,<sup>49</sup> O. Surányi,<sup>49</sup> G. I. Veres,<sup>49</sup> G. Bencze,<sup>50</sup> C. Hajdu,<sup>50</sup> D. Horvath,<sup>50,x</sup> F. Sikler,<sup>50</sup> T. Á. Vámi,<sup>50</sup> V. Veszpremi,<sup>50</sup> G. Vesztergombi,<sup>50,a,y</sup> N. Beni,<sup>51</sup> S. Czellar,<sup>51</sup> J. Karancsi,<sup>51,w</sup> A. Makovec,<sup>51</sup> J. Molnar,<sup>51</sup> Z. Szillasi,<sup>51</sup> P. Raics,<sup>52</sup> D. Teyssier,<sup>52</sup> Z. L. Trocsanyi,<sup>52</sup> B. Ujvari,<sup>52</sup> T. F. Csorgo,<sup>53</sup> W. J. Metzger,<sup>53</sup> F. Nemes,<sup>53</sup> T. Novak,<sup>53</sup> S. Choudhury,<sup>54</sup> J. R. Komaragiri,<sup>54</sup> P. C. Tiwari,<sup>54</sup> S. Bahinipati,<sup>55,z</sup> C. Kar,<sup>55</sup> G. Kole,<sup>55</sup> P. Mal,<sup>55</sup> V. K. Muraleedharan Nair Bindhu,<sup>55</sup> A. Nayak,<sup>55,aa</sup> D. K. Sahoo,<sup>55,z</sup> S. K. Swain,<sup>55</sup> S. Bansal,<sup>56</sup> S. B. Beri,<sup>56</sup> V. Bhatnagar,<sup>56</sup> S. Chauhan,<sup>56</sup> R. Chawla,<sup>56</sup> N. Dhingra,<sup>56</sup> R. Gupta,<sup>56</sup> A. Kaur,<sup>56</sup> M. Kaur,<sup>56</sup> S. Kaur,<sup>56</sup> P. Kumari,<sup>56</sup> M. Lohan,<sup>56</sup> M. Meena,<sup>56</sup> K. Sandeep,<sup>56</sup> S. Sharma,<sup>56</sup> J. B. Singh,<sup>56</sup> A. K. Viridi,<sup>56</sup> G. Walia,<sup>56</sup> A. Bhardwaj,<sup>57</sup> B. C. Choudhary,<sup>57</sup> R. B. Garg,<sup>57</sup> M. Gola,<sup>57</sup> S. Keshri,<sup>57</sup> Ashok Kumar,<sup>57</sup> S. Malhotra,<sup>57</sup> M. Naimuddin,<sup>57</sup> P. Priyanka,<sup>57</sup> K. Ranjan,<sup>57</sup> Aashaq Shah,<sup>57</sup> R. Sharma,<sup>57</sup> R. Bhardwaj,<sup>58,bb</sup> M. Bharti,<sup>58,bb</sup> R. Bhattacharya,<sup>58</sup> S. Bhattacharya,<sup>58</sup> U. Bhawandeep,<sup>58,bb</sup> D. Bhowmik,<sup>58</sup> S. Dey,<sup>58</sup> S. Dutta,<sup>58</sup> S. Ghosh,<sup>58</sup> M. Maity,<sup>58,cc</sup> K. Mondal,<sup>58</sup> S. Nandan,<sup>58</sup> A. Purohit,<sup>58</sup> P. K. Rout,<sup>58</sup> A. Roy,<sup>58</sup> G. Saha,<sup>58</sup> S. Sarkar,<sup>58</sup> T. Sarkar,<sup>58,cc</sup> M. Sharan,<sup>58</sup> B. Singh,<sup>58,bb</sup> S. Thakur,<sup>58,bb</sup> P. K. Behera,<sup>59</sup> P. Kalbhor,<sup>59</sup> A. Muhammad,<sup>59</sup> P. R. Pujahari,<sup>59</sup> A. Sharma,<sup>59</sup> A. K. Sikdar,<sup>59</sup> R. Chudasama,<sup>60</sup> D. Dutta,<sup>60</sup> V. Jha,<sup>60</sup> V. Kumar,<sup>60</sup> D. K. Mishra,<sup>60</sup> P. K. Netrakanti,<sup>60</sup> L. M. Pant,<sup>60</sup> P. Shukla,<sup>60</sup> T. Aziz,<sup>61</sup> M. A. Bhat,<sup>61</sup> S. Dugad,<sup>61</sup> G. B. Mohanty,<sup>61</sup> N. Sur,<sup>61</sup> R. Kumar Verma,<sup>61</sup> S. Banerjee,<sup>62</sup> S. Bhattacharya,<sup>62</sup> S. Chatterjee,<sup>62</sup>



P. Das,<sup>62</sup> M. Guchait,<sup>62</sup> S. Karmakar,<sup>62</sup> S. Kumar,<sup>62</sup> G. Majumder,<sup>62</sup> K. Mazumdar,<sup>62</sup> N. Sahoo,<sup>62</sup> S. Sawant,<sup>62</sup> S. Chauhan,<sup>63</sup> S. Dube,<sup>63</sup> V. Hegde,<sup>63</sup> A. Kapoor,<sup>63</sup> K. Kothekar,<sup>63</sup> S. Pandey,<sup>63</sup> A. Rane,<sup>63</sup> A. Rastogi,<sup>63</sup> S. Sharma,<sup>63</sup> S. Chenarani,<sup>64,dd</sup> E. Eskandari Tadavani,<sup>64</sup> S. M. Etesami,<sup>64,dd</sup> M. Khakzad,<sup>64</sup> M. Mohammadi Najafabadi,<sup>64</sup> M. Naseri,<sup>64</sup> F. Rezaei Hosseinabadi,<sup>64</sup> M. Felcini,<sup>65</sup> M. Grunewald,<sup>65</sup> M. Abbrescia,<sup>66a,66b</sup> C. Calabria,<sup>66a,66b</sup> A. Colaleo,<sup>66a</sup> D. Creanza,<sup>66a,66c</sup> L. Cristella,<sup>66a,66b</sup> N. De Filippis,<sup>66a,66c</sup> M. De Palma,<sup>66a,66b</sup> A. Di Florio,<sup>66a,66b</sup> L. Fiore,<sup>66a</sup> A. Gelmi,<sup>66a,66b</sup> G. Iaselli,<sup>66a,66c</sup> M. Ince,<sup>66a,66b</sup> S. Lezki,<sup>66a,66b</sup> G. Maggi,<sup>66a,66c</sup> M. Maggi,<sup>66a</sup> G. Miniello,<sup>66a,66b</sup> S. My,<sup>66a,66b</sup> S. Nuzzo,<sup>66a,66b</sup> A. Pompili,<sup>66a,66b</sup> G. Pugliese,<sup>66a,66c</sup> R. Radogna,<sup>66a</sup> A. Ranieri,<sup>66a</sup> G. Selvaggi,<sup>66a,66b</sup> L. Silvestris,<sup>66a</sup> R. Venditti,<sup>66a</sup> P. Verwilligen,<sup>66a</sup> G. Abbiendi,<sup>67a</sup> C. Battilana,<sup>67a,67b</sup> D. Bonacorsi,<sup>67a,67b</sup> L. Borgonovi,<sup>67a,67b</sup> S. Braibant-Giacomelli,<sup>67a,67b</sup> R. Campanini,<sup>67a,67b</sup> P. Capiluppi,<sup>67a,67b</sup> A. Castro,<sup>67a,67b</sup> F. R. Cavallo,<sup>67a</sup> C. Ciocca,<sup>67a</sup> G. Codispoti,<sup>67a,67b</sup> M. Cuffiani,<sup>67a,67b</sup> G. M. Dallavalle,<sup>67a</sup> F. Fabbri,<sup>67a</sup> A. Fanfani,<sup>67a,67b</sup> E. Fontanesi,<sup>67a</sup> P. Giacomelli,<sup>67a</sup> C. Grandi,<sup>67a</sup> L. Guiducci,<sup>67a,67b</sup> F. Iemmi,<sup>67a,67b</sup> S. Lo Meo,<sup>67a,ee</sup> S. Marcellini,<sup>67a</sup> G. Masetti,<sup>67a</sup> F. L. Navarra,<sup>67a,67b</sup> A. Perrotta,<sup>67a</sup> F. Primavera,<sup>67a,67b</sup> A. M. Rossi,<sup>67a,67b</sup> T. Rovelli,<sup>67a,67b</sup> G. P. Siroli,<sup>67a,67b</sup> N. Tosi,<sup>67a</sup> S. Albergo,<sup>68a,68b,ff</sup> S. Costa,<sup>68a,68b</sup> A. Di Mattia,<sup>68a</sup> R. Potenza,<sup>68a,68b</sup> A. Tricomi,<sup>68a,68b,ff</sup> C. Tuve,<sup>68a,68b</sup> G. Barbagli,<sup>69a</sup> R. Ceccarelli,<sup>69a</sup> K. Chatterjee,<sup>69a,69b</sup> V. Ciulli,<sup>69a,69b</sup> C. Civinini,<sup>69a</sup> R. D'Alessandro,<sup>69a,69b</sup> E. Focardi,<sup>69a,69b</sup> G. Latino,<sup>69a</sup> P. Lenzi,<sup>69a,69b</sup> M. Meschini,<sup>69a</sup> S. Paoletti,<sup>69a</sup> G. Sguazzoni,<sup>69a</sup> D. Strom,<sup>69a</sup> L. Viliani,<sup>69a</sup> L. Benussi,<sup>70</sup> S. Bianco,<sup>70</sup> D. Piccolo,<sup>70</sup> M. Bozzo,<sup>71a,71b</sup> F. Ferro,<sup>71a</sup> R. Mulargia,<sup>71a,71b</sup> E. Robutti,<sup>71a</sup> S. Tosi,<sup>71a,71b</sup> A. Benaglia,<sup>72a</sup> A. Beschi,<sup>72a,72b</sup> F. Brivio,<sup>72a,72b</sup> V. Ciriolo,<sup>72a,72b,s</sup> S. Di Guida,<sup>72a,72b,s</sup> M. E. Dinardo,<sup>72a,72b</sup> P. Dini,<sup>72a</sup> S. Fiorendi,<sup>72a,72b</sup> S. Gennai,<sup>72a</sup> A. Ghezzi,<sup>72a,72b</sup> P. Govoni,<sup>72a,72b</sup> L. Guzzi,<sup>72a,72b</sup> M. Malberti,<sup>72a</sup> S. Malvezzi,<sup>72a</sup> D. Menasce,<sup>72a</sup> F. Monti,<sup>72a,72b</sup> L. Moroni,<sup>72a</sup> G. Ortona,<sup>72a,72b</sup> M. Paganoni,<sup>72a,72b</sup> D. Pedrini,<sup>72a</sup> S. Ragazzi,<sup>72a,72b</sup> T. Tabarelli de Fatis,<sup>72a,72b</sup> D. Zuolo,<sup>72a,72b</sup> S. Buontempo,<sup>73a</sup> N. Cavallo,<sup>73a,73c</sup> A. De Iorio,<sup>73a,73b</sup> A. Di Crescenzo,<sup>73a,73b</sup> F. Fabozzi,<sup>73a,73c</sup> F. Fienga,<sup>73a</sup> G. Galati,<sup>73a</sup> A. O. M. Iorio,<sup>73a,73b</sup> L. Lista,<sup>73a,73b</sup> S. Meola,<sup>73a,73d,s</sup> P. Paolucci,<sup>73a,s</sup> B. Rossi,<sup>73a</sup> C. Sciacca,<sup>73a,73b</sup> E. Voevodina,<sup>73a,73b</sup> P. Azzi,<sup>74a</sup> N. Bacchetta,<sup>74a</sup> A. Boletti,<sup>74a,74b</sup> A. Bragagnolo,<sup>74a</sup> R. Carlin,<sup>74a,74b</sup> P. Checchia,<sup>74a</sup> P. De Castro Manzano,<sup>74a</sup> T. Dorigo,<sup>74a</sup> U. Dosselli,<sup>74a</sup> F. Gasparini,<sup>74a,74b</sup> U. Gasparini,<sup>74a,74b</sup> A. Gozzelino,<sup>74a</sup> S. Y. Hoh,<sup>74a</sup> P. Lujan,<sup>74a</sup> M. Margoni,<sup>74a,74b</sup> A. T. Meneguzzo,<sup>74a,74b</sup> J. Pazzini,<sup>74a,74b</sup> N. Pozzobon,<sup>74a,74b</sup> M. Presilla,<sup>74a,74b</sup> P. Ronchese,<sup>74a,74b</sup> R. Rossin,<sup>74a,74b</sup> F. Simonetto,<sup>74a,74b</sup> A. Tiko,<sup>74a</sup> M. Tosi,<sup>74a,74b</sup> M. Zanetti,<sup>74a,74b</sup> P. Zotto,<sup>74a,74b</sup> G. Zumerle,<sup>74a,74b</sup> A. Braghieri,<sup>75a</sup> P. Montagna,<sup>75a,75b</sup> S. P. Ratti,<sup>75a,75b</sup> V. Re,<sup>75a</sup> M. Ressegotti,<sup>75a,75b</sup> C. Riccardi,<sup>75a,75b</sup> P. Salvini,<sup>75a</sup> I. Vai,<sup>75a,75b</sup> P. Vitulo,<sup>75a,75b</sup> M. Biasini,<sup>76a,76b</sup> G. M. Bilei,<sup>76a</sup> C. Cecchi,<sup>76a,76b</sup> D. Ciangottini,<sup>76a,76b</sup> L. Fanò,<sup>76a,76b</sup> P. Lariccia,<sup>76a,76b</sup> R. Leonardi,<sup>76a,76b</sup> E. Manoni,<sup>76a</sup> G. Mantovani,<sup>76a,76b</sup> V. Mariani,<sup>76a,76b</sup> M. Menichelli,<sup>76a</sup> A. Rossi,<sup>76a,76b</sup> A. Santocchia,<sup>76a,76b</sup> D. Spiga,<sup>76a</sup> K. Androsov,<sup>77a</sup> P. Azzurri,<sup>77a</sup> G. Bagliesi,<sup>77a</sup> V. Bertacchi,<sup>77a,77c</sup> L. Bianchini,<sup>77a</sup> T. Boccali,<sup>77a</sup> R. Castaldi,<sup>77a</sup> M. A. Ciocci,<sup>77a,77b</sup> R. Dell'Orso,<sup>77a</sup> G. Fedi,<sup>77a</sup> L. Giannini,<sup>77a,77c</sup> A. Giassi,<sup>77a</sup> M. T. Grippo,<sup>77a</sup> F. Ligabue,<sup>77a,77c</sup> E. Manca,<sup>77a,77c</sup> G. Mandorli,<sup>77a,77c</sup> A. Messineo,<sup>77a,77b</sup> F. Palla,<sup>77a</sup> A. Rizzi,<sup>77a,77b</sup> G. Rolandi,<sup>77a,gg</sup> S. Roy Chowdhury,<sup>77a</sup> A. Scribano,<sup>77a</sup> P. Spagnolo,<sup>77a</sup> R. Tenchini,<sup>77a</sup> G. Tonelli,<sup>77a,77b</sup> N. Turini,<sup>77a</sup> A. Venturi,<sup>77a</sup> P. G. Verdini,<sup>77a</sup> F. Cavallari,<sup>78a</sup> M. Cipriani,<sup>78a,78b</sup> D. Del Re,<sup>78a,78b</sup> E. Di Marco,<sup>78a,78b</sup> M. Diemoz,<sup>78a</sup> E. Longo,<sup>78a,78b</sup> B. Marzocchi,<sup>78a,78b</sup> P. Meridiani,<sup>78a</sup> G. Organtini,<sup>78a,78b</sup> F. Pandolfi,<sup>78a</sup> R. Paramatti,<sup>78a,78b</sup> C. Quaranta,<sup>78a,78b</sup> S. Rahatlou,<sup>78a,78b</sup> C. Rovelli,<sup>78a</sup> F. Santanastasio,<sup>78a,78b</sup> L. Soffi,<sup>78a,78b</sup> N. Amapane,<sup>79a,79b</sup> R. Arcidiacono,<sup>79a,79c</sup> S. Argiro,<sup>79a,79b</sup> M. Arneodo,<sup>79a,79c</sup> N. Bartosik,<sup>79a</sup> R. Bellan,<sup>79a,79b</sup> C. Biino,<sup>79a</sup> A. Cappati,<sup>79a,79b</sup> N. Cartiglia,<sup>79a</sup> S. Cometti,<sup>79a</sup> M. Costa,<sup>79a,79b</sup> R. Covarelli,<sup>79a,79b</sup> N. Demaria,<sup>79a</sup> B. Kiani,<sup>79a,79b</sup> C. Mariotti,<sup>79a</sup> S. Maselli,<sup>79a</sup> E. Migliore,<sup>79a,79b</sup> V. Monaco,<sup>79a,79b</sup> E. Monteil,<sup>79a,79b</sup> M. Monteno,<sup>79a</sup> M. M. Obertino,<sup>79a,79b</sup> L. Pacher,<sup>79a,79b</sup> N. Pastrone,<sup>79a</sup> M. Pelliccioni,<sup>79a</sup> G. L. Pinna Angioni,<sup>79a,79b</sup> A. Romero,<sup>79a,79b</sup> M. Ruspa,<sup>79a,79c</sup> R. Sacchi,<sup>79a,79b</sup> R. Salvatico,<sup>79a,79b</sup> K. Shchelina,<sup>79a,79b</sup> V. Sola,<sup>79a</sup> A. Solano,<sup>79a,79b</sup> D. Soldi,<sup>79a,79b</sup> A. Staiano,<sup>79a</sup> S. Belforte,<sup>80a</sup> V. Candelise,<sup>80a,80b</sup> M. Casarsa,<sup>80a</sup> F. Cossutti,<sup>80a</sup> A. Da Rold,<sup>80a,80b</sup> G. Della Ricca,<sup>80a,80b</sup> F. Vazzoler,<sup>80a,80b</sup> A. Zanetti,<sup>80a</sup> B. Kim,<sup>81</sup> D. H. Kim,<sup>81</sup> G. N. Kim,<sup>81</sup> M. S. Kim,<sup>81</sup> J. Lee,<sup>81</sup> S. W. Lee,<sup>81</sup> C. S. Moon,<sup>81</sup> Y. D. Oh,<sup>81</sup> S. I. Pak,<sup>81</sup> S. Sekmen,<sup>81</sup> D. C. Son,<sup>81</sup> Y. C. Yang,<sup>81</sup> H. Kim,<sup>82</sup> D. H. Moon,<sup>82</sup> G. Oh,<sup>82</sup> B. Francois,<sup>83</sup> T. J. Kim,<sup>83</sup> J. Park,<sup>83</sup> S. Cho,<sup>84</sup> S. Choi,<sup>84</sup> Y. Go,<sup>84</sup> D. Gyun,<sup>84</sup> S. Ha,<sup>84</sup> B. Hong,<sup>84</sup> K. Lee,<sup>84</sup> K. S. Lee,<sup>84</sup> J. Lim,<sup>84</sup> J. Park,<sup>84</sup> S. K. Park,<sup>84</sup> Y. Roh,<sup>84</sup> J. Goh,<sup>85</sup> H. S. Kim,<sup>86</sup> J. Almond,<sup>87</sup> J. H. Bhyun,<sup>87</sup> J. Choi,<sup>87</sup> S. Jeon,<sup>87</sup> J. Kim,<sup>87</sup> J. S. Kim,<sup>87</sup> H. Lee,<sup>87</sup> K. Lee,<sup>87</sup> S. Lee,<sup>87</sup> K. Nam,<sup>87</sup> S. B. Oh,<sup>87</sup> B. C. Radburn-Smith,<sup>87</sup> S. h. Seo,<sup>87</sup> U. K. Yang,<sup>87</sup> H. D. Yoo,<sup>87</sup> I. Yoon,<sup>87</sup> G. B. Yu,<sup>87</sup> D. Jeon,<sup>88</sup> H. Kim,<sup>88</sup> J. H. Kim,<sup>88</sup> J. S. H. Lee,<sup>88</sup> I. C. Park,<sup>88</sup> I. Watson,<sup>88</sup> Y. Choi,<sup>89</sup> C. Hwang,<sup>89</sup> Y. Jeong,<sup>89</sup> J. Lee,<sup>89</sup> Y. Lee,<sup>89</sup> I. Yu,<sup>89</sup> V. Veckalns,<sup>90,hh</sup> V. Dudenas,<sup>91</sup> A. Juodagalvis,<sup>91</sup> J. Vaitkus,<sup>91</sup> Z. A. Ibrahim,<sup>92</sup> F. Mohamad Idris,<sup>92,ii</sup> W. A. T. Wan Abdullah,<sup>92</sup> M. N. Yusli,<sup>92</sup> Z. Zolkapli,<sup>92</sup> J. F. Benitez,<sup>93</sup> A. Castaneda Hernandez,<sup>93</sup> J. A. Murillo Quijada,<sup>93</sup> L. Valencia Palomo,<sup>93</sup> H. Castilla-Valdez,<sup>94</sup> E. De La Cruz-Burelo,<sup>94</sup> I. Heredia-De La Cruz,<sup>94,jj</sup> R. Lopez-Fernandez,<sup>94</sup>



A. Sanchez-Hernandez,<sup>94</sup> S. Carrillo Moreno,<sup>95</sup> C. Oropeza Barrera,<sup>95</sup> M. Ramirez-Garcia,<sup>95</sup> F. Vazquez Valencia,<sup>95</sup>  
 J. Eysermans,<sup>96</sup> I. Pedraza,<sup>96</sup> H. A. Salazar Ibarguen,<sup>96</sup> C. Uribe Estrada,<sup>96</sup> A. Morelos Pineda,<sup>97</sup> N. Raicevic,<sup>98</sup>  
 D. Krofcheck,<sup>99</sup> S. Bheesette,<sup>100</sup> P. H. Butler,<sup>100</sup> A. Ahmad,<sup>101</sup> M. Ahmad,<sup>101</sup> Q. Hassan,<sup>101</sup> H. R. Hoorani,<sup>101</sup> W. A. Khan,<sup>101</sup>  
 M. A. Shah,<sup>101</sup> M. Shoaib,<sup>101</sup> M. Waqas,<sup>101</sup> V. Avati,<sup>102</sup> L. Grzanka,<sup>102</sup> M. Malawski,<sup>102</sup> H. Bialkowska,<sup>103</sup> M. Bluj,<sup>103</sup>  
 B. Boimska,<sup>103</sup> M. Górski,<sup>103</sup> M. Kazana,<sup>103</sup> M. Szeleper,<sup>103</sup> P. Zalewski,<sup>103</sup> K. Bunkowski,<sup>104</sup> A. Byszek,<sup>104,kk</sup> K. Doroba,<sup>104</sup>  
 A. Kalinowski,<sup>104</sup> M. Konecki,<sup>104</sup> J. Krolikowski,<sup>104</sup> M. Misiura,<sup>104</sup> M. Olszewski,<sup>104</sup> A. Pyskir,<sup>104</sup> M. Walczak,<sup>104</sup>  
 M. Araujo,<sup>105</sup> P. Bargassa,<sup>105</sup> D. Bastos,<sup>105</sup> A. Di Francesco,<sup>105</sup> P. Faccioli,<sup>105</sup> B. Galinhas,<sup>105</sup> M. Gallinaro,<sup>105</sup> J. Hollar,<sup>105</sup>  
 N. Leonardo,<sup>105</sup> J. Seixas,<sup>105</sup> G. Strong,<sup>105</sup> O. Toldaiev,<sup>105</sup> J. Varela,<sup>105</sup> S. Afanasiev,<sup>106</sup> P. Bunin,<sup>106</sup> M. Gavrilenko,<sup>106</sup>  
 I. Golutvin,<sup>106</sup> I. Gorbunov,<sup>106</sup> A. Kamenev,<sup>106</sup> V. Karjavine,<sup>106</sup> A. Lanev,<sup>106</sup> A. Malakhov,<sup>106</sup> V. Matveev,<sup>106,ll,mm</sup>  
 P. Moisenz,<sup>106</sup> V. Palichik,<sup>106</sup> V. Perelygin,<sup>106</sup> M. Savina,<sup>106</sup> S. Shmatov,<sup>106</sup> S. Shulha,<sup>106</sup> N. Skatchkov,<sup>106</sup> V. Smirnov,<sup>106</sup>  
 N. Voytishin,<sup>106</sup> A. Zarubin,<sup>106</sup> L. Chtchipounov,<sup>107</sup> V. Golovtsov,<sup>107</sup> Y. Ivanov,<sup>107</sup> V. Kim,<sup>107,nn</sup> E. Kuznetsova,<sup>107,oo</sup>  
 P. Levchenko,<sup>107</sup> V. Murzin,<sup>107</sup> V. Oreshkin,<sup>107</sup> I. Smirnov,<sup>107</sup> D. Sosnov,<sup>107</sup> V. Sulimov,<sup>107</sup> L. Uvarov,<sup>107</sup> A. Vorobyev,<sup>107</sup>  
 Yu. Andreev,<sup>108</sup> A. Dermenev,<sup>108</sup> S. Gninenko,<sup>108</sup> N. Golubev,<sup>108</sup> A. Karneyeu,<sup>108</sup> M. Kirsanov,<sup>108</sup> N. Krasnikov,<sup>108</sup>  
 A. Pashenkov,<sup>108</sup> D. Tlisov,<sup>108</sup> A. Toropin,<sup>108</sup> V. Epshteyn,<sup>109</sup> V. Gavrilo, <sup>109</sup> N. Lychkovskaya,<sup>109</sup> A. Nikitenko,<sup>109,pp</sup>  
 V. Popov,<sup>109</sup> I. Pozdnyakov,<sup>109</sup> G. Safronov,<sup>109</sup> A. Spiridonov,<sup>109</sup> A. Steppenov,<sup>109</sup> M. Toms,<sup>109</sup> E. Vlasov,<sup>109</sup> A. Zhokin,<sup>109</sup>  
 T. Aushv,<sup>110</sup> O. Bychkova,<sup>111</sup> R. Chistov,<sup>111,qq</sup> M. Danilov,<sup>111,qq</sup> S. Polikarpov,<sup>111,qq</sup> E. Tarkovskii,<sup>111</sup> V. Andreev,<sup>112</sup>  
 M. Azarkin,<sup>112</sup> I. Dremin,<sup>112</sup> M. Kirakosyan,<sup>112</sup> A. Terkulov,<sup>112</sup> A. Baskakov,<sup>113</sup> A. Belyaev,<sup>113</sup> E. Boos,<sup>113</sup> V. Bunichev,<sup>113</sup>  
 M. Dubinin,<sup>113,rr</sup> L. Dudko,<sup>113</sup> V. Klyukhin,<sup>113</sup> N. Korneeva,<sup>113</sup> I. Lokhtin,<sup>113</sup> S. Obraztsov,<sup>113</sup> M. Perfilov,<sup>113</sup> V. Savrin,<sup>113</sup>  
 P. Volkov,<sup>113</sup> A. Barnyakov,<sup>114,ss</sup> V. Blinov,<sup>114,ss</sup> T. Dimova,<sup>114,ss</sup> L. Kardapoltsev,<sup>114,ss</sup> Y. Skovpen,<sup>114,ss</sup> I. Azhgirey,<sup>115</sup>  
 I. Bayshev,<sup>115</sup> S. Bitioukov,<sup>115</sup> V. Kachanov,<sup>115</sup> D. Konstantinov,<sup>115</sup> P. Mandrik,<sup>115</sup> V. Petrov,<sup>115</sup> R. Ryutin,<sup>115</sup>  
 S. Slabospitskii,<sup>115</sup> A. Sobol,<sup>115</sup> S. Troshin,<sup>115</sup> N. Tyurin,<sup>115</sup> A. Uzunian,<sup>115</sup> A. Volkov,<sup>115</sup> A. Babaev,<sup>116</sup> A. Iuzhakov,<sup>116</sup>  
 V. Okhotnikov,<sup>116</sup> V. Borchsh,<sup>117</sup> V. Ivanchenko,<sup>117</sup> E. Tcherniaev,<sup>117</sup> P. Adzic,<sup>118,tt</sup> P. Cirkovic,<sup>118</sup> D. Devetak,<sup>118</sup>  
 M. Dordevic,<sup>118</sup> P. Milenovic,<sup>118</sup> J. Milosevic,<sup>118</sup> M. Stojanovic,<sup>118</sup> M. Aguilar-Benitez,<sup>119</sup> J. Alcaraz Maestre,<sup>119</sup>  
 A. Álvarez Fernández,<sup>119</sup> I. Bachiller,<sup>119</sup> M. Barrio Luna,<sup>119</sup> J. A. Brochero Cifuentes,<sup>119</sup> C. A. Carrillo Montoya,<sup>119</sup>  
 M. Cepeda,<sup>119</sup> M. Cerrada,<sup>119</sup> N. Colino,<sup>119</sup> B. De La Cruz,<sup>119</sup> A. Delgado Peris,<sup>119</sup> C. Fernandez Bedoya,<sup>119</sup>  
 J. P. Fernández Ramos,<sup>119</sup> J. Flix,<sup>119</sup> M. C. Fouz,<sup>119</sup> O. Gonzalez Lopez,<sup>119</sup> S. Goy Lopez,<sup>119</sup> J. M. Hernandez,<sup>119</sup>  
 M. I. Josa,<sup>119</sup> D. Moran,<sup>119</sup> Á. Navarro Tobar,<sup>119</sup> A. Pérez-Calero Yzquierdo,<sup>119</sup> J. Puerta Pelayo,<sup>119</sup> I. Redondo,<sup>119</sup>  
 L. Romero,<sup>119</sup> S. Sánchez Navas,<sup>119</sup> M. S. Soares,<sup>119</sup> A. Triossi,<sup>119</sup> C. Willmott,<sup>119</sup> C. Albajar,<sup>120</sup> J. F. de Trocóniz,<sup>120</sup>  
 B. Alvarez Gonzalez,<sup>121</sup> J. Cuevas,<sup>121</sup> C. Erice,<sup>121</sup> J. Fernandez Menendez,<sup>121</sup> S. Folgueras,<sup>121</sup> I. Gonzalez Caballero,<sup>121</sup>  
 J. R. González Fernández,<sup>121</sup> E. Palencia Cortezon,<sup>121</sup> V. Rodríguez Bouza,<sup>121</sup> S. Sanchez Cruz,<sup>121</sup> I. J. Cabrillo,<sup>122</sup>  
 A. Calderon,<sup>122</sup> B. Chazin Quero,<sup>122</sup> J. Duarte Campderros,<sup>122</sup> M. Fernandez,<sup>122</sup> P. J. Fernández Manteca,<sup>122</sup>  
 A. García Alonso,<sup>122</sup> G. Gomez,<sup>122</sup> C. Martinez Rivero,<sup>122</sup> P. Martinez Ruiz del Arbol,<sup>122</sup> F. Matorras,<sup>122</sup> J. Piedra Gomez,<sup>122</sup>  
 C. Prieels,<sup>122</sup> T. Rodrigo,<sup>122</sup> A. Ruiz-Jimeno,<sup>122</sup> L. Russo,<sup>122,uu</sup> L. Scodellaro,<sup>122</sup> N. Trevisani,<sup>122</sup> I. Vila,<sup>122</sup>  
 J. M. Vizan Garcia,<sup>122</sup> K. Malagalage,<sup>123</sup> W. G. D. Dharmaratna,<sup>124</sup> N. Wickramage,<sup>124</sup> D. Abbaneo,<sup>125</sup> B. Akgun,<sup>125</sup>  
 E. Auffray,<sup>125</sup> G. Auzinger,<sup>125</sup> J. Baechler,<sup>125</sup> P. Baillon,<sup>125</sup> A. H. Ball,<sup>125</sup> D. Barney,<sup>125</sup> J. Bendavid,<sup>125</sup> M. Bianco,<sup>125</sup>  
 A. Bocci,<sup>125</sup> E. Bossini,<sup>125</sup> C. Botta,<sup>125</sup> E. Brondolin,<sup>125</sup> T. Camporesi,<sup>125</sup> A. Caratelli,<sup>125</sup> G. Cerminara,<sup>125</sup> E. Chapon,<sup>125</sup>  
 G. Cucciati,<sup>125</sup> D. d'Enterria,<sup>125</sup> A. Dabrowski,<sup>125</sup> N. Daci,<sup>125</sup> V. Daponte,<sup>125</sup> A. David,<sup>125</sup> O. Davignon,<sup>125</sup> A. De Roeck,<sup>125</sup>  
 N. Deelen,<sup>125</sup> M. Deile,<sup>125</sup> M. Dobson,<sup>125</sup> M. Dünser,<sup>125</sup> N. Dupont,<sup>125</sup> A. Elliott-Peisert,<sup>125</sup> F. Fallavollita,<sup>125,vv</sup>  
 D. Fasanella,<sup>125</sup> G. Franzoni,<sup>125</sup> J. Fulcher,<sup>125</sup> W. Funk,<sup>125</sup> S. Giani,<sup>125</sup> D. Gigi,<sup>125</sup> A. Gilbert,<sup>125</sup> K. Gill,<sup>125</sup> F. Glege,<sup>125</sup>  
 M. Gruchala,<sup>125</sup> M. Guilbaud,<sup>125</sup> D. Gulhan,<sup>125</sup> J. Hegeman,<sup>125</sup> C. Heidegger,<sup>125</sup> Y. Iiyama,<sup>125</sup> V. Innocente,<sup>125</sup> P. Janot,<sup>125</sup>  
 O. Karacheban,<sup>125,v</sup> J. Kaspar,<sup>125</sup> J. Kieseler,<sup>125</sup> M. Krammer,<sup>125,b</sup> C. Lange,<sup>125</sup> P. Lecoq,<sup>125</sup> C. Lourenço,<sup>125</sup> L. Malgeri,<sup>125</sup>  
 M. Mannelli,<sup>125</sup> A. Massironi,<sup>125</sup> F. Meijers,<sup>125</sup> J. A. Merlin,<sup>125</sup> S. Mersi,<sup>125</sup> E. Meschi,<sup>125</sup> F. Moortgat,<sup>125</sup> M. Mulders,<sup>125</sup>  
 J. Ngadiuba,<sup>125</sup> S. Nourbakhsh,<sup>125</sup> S. Orfanelli,<sup>125</sup> L. Orsini,<sup>125</sup> F. Pantaleo,<sup>125,s</sup> L. Pape,<sup>125</sup> E. Perez,<sup>125</sup> M. Peruzzi,<sup>125</sup>  
 A. Petrilli,<sup>125</sup> G. Petrucciani,<sup>125</sup> A. Pfeiffer,<sup>125</sup> M. Pierini,<sup>125</sup> F. M. Pitters,<sup>125</sup> M. Quinto,<sup>125</sup> D. Rabady,<sup>125</sup> A. Racz,<sup>125</sup>  
 M. Rovere,<sup>125</sup> H. Sakulin,<sup>125</sup> C. Schäfer,<sup>125</sup> C. Schwick,<sup>125</sup> M. Selvaggi,<sup>125</sup> A. Sharma,<sup>125</sup> P. Silva,<sup>125</sup> W. Snoeys,<sup>125</sup>  
 P. Sphicas,<sup>125,ww</sup> J. Stegmann,<sup>125</sup> V. R. Tavolaro,<sup>125</sup> D. Treille,<sup>125</sup> A. Tsirou,<sup>125</sup> A. Vartak,<sup>125</sup> M. Verzetti,<sup>125</sup>  
 W. D. Zeuner,<sup>125</sup> L. Caminada,<sup>126,xx</sup> K. Deiters,<sup>126</sup> W. Erdmann,<sup>126</sup> R. Horisberger,<sup>126</sup> Q. Ingram,<sup>126</sup> H. C. Kaestli,<sup>126</sup>  
 D. Kotlinski,<sup>126</sup> U. Langenegger,<sup>126</sup> T. Rohe,<sup>126</sup> S. A. Wiederkehr,<sup>126</sup> M. Backhaus,<sup>127</sup> P. Berger,<sup>127</sup> N. Chernyavskaya,<sup>127</sup>  
 G. Dissertori,<sup>127</sup> M. Dittmar,<sup>127</sup> M. Donegà,<sup>127</sup> C. Dorfer,<sup>127</sup> T. A. Gómez Espinosa,<sup>127</sup> C. Grab,<sup>127</sup> D. Hits,<sup>127</sup> T. Klijnsma,<sup>127</sup>

W. Luster, <sup>127</sup> R. A. Manzoni, <sup>127</sup> M. Marionneau, <sup>127</sup> M. T. Meinhard, <sup>127</sup> F. Micheli, <sup>127</sup> P. Musella, <sup>127</sup>  
 F. Nessi-Tedaldi, <sup>127</sup> F. Pauss, <sup>127</sup> G. Perrin, <sup>127</sup> L. Perrozzi, <sup>127</sup> S. Pigazzini, <sup>127</sup> M. Reichmann, <sup>127</sup> C. Reissel, <sup>127</sup>  
 T. Reitspiess, <sup>127</sup> D. Ruini, <sup>127</sup> D. A. Sanz Becerra, <sup>127</sup> M. Schönenberger, <sup>127</sup> L. Shchutska, <sup>127</sup> M. L. Vesterbacka Olsson, <sup>127</sup>  
 R. Wallny, <sup>127</sup> D. H. Zhu, <sup>127</sup> T. K. Aarrestad, <sup>128</sup> C. Amsler, <sup>128,yy</sup> D. Brzhechko, <sup>128</sup> M. F. Canelli, <sup>128</sup> A. De Cosa, <sup>128</sup>  
 R. Del Burgo, <sup>128</sup> S. Donato, <sup>128</sup> B. Kilminster, <sup>128</sup> S. Leontsinis, <sup>128</sup> V. M. Mikuni, <sup>128</sup> I. Neutelings, <sup>128</sup> G. Rauco, <sup>128</sup>  
 P. Robmann, <sup>128</sup> D. Salerno, <sup>128</sup> K. Schweiger, <sup>128</sup> C. Seitz, <sup>128</sup> Y. Takahashi, <sup>128</sup> S. Wertz, <sup>128</sup> A. Zucchetta, <sup>128</sup> T. H. Doan, <sup>129</sup>  
 C. M. Kuo, <sup>129</sup> W. Lin, <sup>129</sup> S. S. Yu, <sup>129</sup> P. Chang, <sup>130</sup> Y. Chao, <sup>130</sup> K. F. Chen, <sup>130</sup> P. H. Chen, <sup>130</sup> W.-S. Hou, <sup>130</sup> Y. y. Li, <sup>130</sup>  
 R.-S. Lu, <sup>130</sup> E. Paganis, <sup>130</sup> A. Psallidas, <sup>130</sup> A. Steen, <sup>130</sup> B. Asavapibhop, <sup>131</sup> N. Srimanobhas, <sup>131</sup> N. Suwonjandee, <sup>131</sup>  
 A. Bat, <sup>132</sup> F. Boran, <sup>132</sup> S. Cerci, <sup>132,zz</sup> S. Damarseckin, <sup>132,aaa</sup> Z. S. Demiroglu, <sup>132</sup> F. Dolek, <sup>132</sup> C. Dozen, <sup>132</sup> I. Dumanoglu, <sup>132</sup>  
 G. Gokbulut, <sup>132</sup> E. Gurpinar Guler, <sup>132,bbb</sup> Y. Guler, <sup>132</sup> I. Hos, <sup>132,ccc</sup> C. Isik, <sup>132</sup> E. E. Kangal, <sup>132,ddd</sup> O. Kara, <sup>132</sup>  
 A. Kayis Topaksu, <sup>132</sup> U. Kiminsu, <sup>132</sup> M. Oglakci, <sup>132</sup> G. Onengut, <sup>132</sup> K. Ozdemir, <sup>132,eee</sup> S. Ozturk, <sup>132,fff</sup> A. E. Simsek, <sup>132</sup>  
 D. Sunar Cerci, <sup>132,zz</sup> U. G. Tok, <sup>132</sup> S. Turkcapar, <sup>132</sup> I. S. Zorbakir, <sup>132</sup> C. Zorbilmez, <sup>132</sup> B. Isildak, <sup>133,ggg</sup> G. Karapinar, <sup>133,hhh</sup>  
 M. Yalvac, <sup>133</sup> I. O. Atakisi, <sup>134</sup> E. Gülmez, <sup>134</sup> M. Kaya, <sup>134,iii</sup> O. Kaya, <sup>134,ijj</sup> B. Kaynak, <sup>134</sup> Ö. Özçelik, <sup>134</sup>  
 S. Ozkorucuklu, <sup>134,kkk</sup> S. Tekten, <sup>134</sup> E. A. Yetkin, <sup>134,lll</sup> A. Cakir, <sup>135</sup> Y. Komurcu, <sup>135</sup> S. Sen, <sup>135,mmm</sup> B. Grynyov, <sup>136</sup>  
 L. Levchuk, <sup>137</sup> F. Ball, <sup>138</sup> E. Bhal, <sup>138</sup> S. Bologna, <sup>138</sup> J. J. Brooke, <sup>138</sup> D. Burns, <sup>138</sup> E. Clement, <sup>138</sup> D. Cussans, <sup>138</sup> H. Flacher, <sup>138</sup>  
 J. Goldstein, <sup>138</sup> G. P. Heath, <sup>138</sup> H. F. Heath, <sup>138</sup> L. Kreczko, <sup>138</sup> S. Paramesvaran, <sup>138</sup> B. Penning, <sup>138</sup> T. Sakuma, <sup>138</sup>  
 S. Seif El Nasr-Storey, <sup>138</sup> D. Smith, <sup>138</sup> V. J. Smith, <sup>138</sup> J. Taylor, <sup>138</sup> A. Titterton, <sup>138</sup> K. W. Bell, <sup>139</sup> A. Belyaev, <sup>139,nnn</sup>  
 C. Brew, <sup>139</sup> R. M. Brown, <sup>139</sup> D. Cieri, <sup>139</sup> D. J. A. Cockerill, <sup>139</sup> J. A. Coughlan, <sup>139</sup> K. Harder, <sup>139</sup> S. Harper, <sup>139</sup> J. Linacre, <sup>139</sup>  
 K. Manolopoulos, <sup>139</sup> D. M. Newbold, <sup>139</sup> E. Olaiya, <sup>139</sup> D. Petyt, <sup>139</sup> T. Reis, <sup>139</sup> T. Schuh, <sup>139</sup>  
 C. H. Shepherd-Themistocleous, <sup>139</sup> A. Thea, <sup>139</sup> I. R. Tomalin, <sup>139</sup> T. Williams, <sup>139</sup> W. J. Womersley, <sup>139</sup> R. Bainbridge, <sup>140</sup>  
 P. Bloch, <sup>140</sup> J. Borg, <sup>140</sup> S. Breeze, <sup>140</sup> O. Buchmuller, <sup>140</sup> A. Bundock, <sup>140</sup> Gurpreet Singh Chahal, <sup>140,ooo</sup> D. Colling, <sup>140</sup>  
 P. Dauncey, <sup>140</sup> G. Davies, <sup>140</sup> M. Della Negra, <sup>140</sup> R. Di Maria, <sup>140</sup> P. Everaerts, <sup>140</sup> G. Hall, <sup>140</sup> G. Iles, <sup>140</sup> T. James, <sup>140</sup>  
 M. Komm, <sup>140</sup> C. Laner, <sup>140</sup> L. Lyons, <sup>140</sup> A.-M. Magnan, <sup>140</sup> S. Malik, <sup>140</sup> A. Martelli, <sup>140</sup> V. Milosevic, <sup>140</sup> J. Nash, <sup>140,ppp</sup>  
 V. Palladino, <sup>140</sup> M. Pesaresi, <sup>140</sup> D. M. Raymond, <sup>140</sup> A. Richards, <sup>140</sup> A. Rose, <sup>140</sup> E. Scott, <sup>140</sup> C. Seez, <sup>140</sup> A. Shtipliyski, <sup>140</sup>  
 M. Stoye, <sup>140</sup> T. Strebler, <sup>140</sup> S. Summers, <sup>140</sup> A. Tapper, <sup>140</sup> K. Uchida, <sup>140</sup> T. Virdee, <sup>140,s</sup> N. Wardle, <sup>140</sup> D. Winterbottom, <sup>140</sup>  
 J. Wright, <sup>140</sup> A. G. Zecchinelli, <sup>140</sup> S. C. Zenz, <sup>140</sup> J. E. Cole, <sup>141</sup> P. R. Hobson, <sup>141</sup> A. Khan, <sup>141</sup> P. Kyberd, <sup>141</sup> C. K. Mackay, <sup>141</sup>  
 A. Morton, <sup>141</sup> I. D. Reid, <sup>141</sup> L. Teodorescu, <sup>141</sup> S. Zahid, <sup>141</sup> K. Call, <sup>142</sup> J. Dittmann, <sup>142</sup> K. Hatakeyama, <sup>142</sup> C. Madrid, <sup>142</sup>  
 B. McMaster, <sup>142</sup> N. Pastika, <sup>142</sup> C. Smith, <sup>142</sup> R. Bartek, <sup>143</sup> A. Dominguez, <sup>143</sup> R. Uniyal, <sup>143</sup> A. Buccilli, <sup>144</sup> S. I. Cooper, <sup>144</sup>  
 C. Henderson, <sup>144</sup> P. Rumerio, <sup>144</sup> C. West, <sup>144</sup> D. Arcaro, <sup>145</sup> T. Bose, <sup>145</sup> Z. Demiragli, <sup>145</sup> D. Gastler, <sup>145</sup> S. Girgis, <sup>145</sup>  
 D. Pinna, <sup>145</sup> C. Richardson, <sup>145</sup> J. Rohlf, <sup>145</sup> D. Sperka, <sup>145</sup> I. Suarez, <sup>145</sup> L. Sulak, <sup>145</sup> D. Zou, <sup>145</sup> G. Benelli, <sup>146</sup> B. Burkle, <sup>146</sup>  
 X. Coubez, <sup>146</sup> D. Cutts, <sup>146</sup> Y. t. Duh, <sup>146</sup> M. Hadley, <sup>146</sup> J. Hakala, <sup>146</sup> U. Heintz, <sup>146</sup> J. M. Hogan, <sup>146,qqq</sup> K. H. M. Kwok, <sup>146</sup>  
 E. Laird, <sup>146</sup> G. Landsberg, <sup>146</sup> J. Lee, <sup>146</sup> Z. Mao, <sup>146</sup> M. Narain, <sup>146</sup> S. Sagir, <sup>146,rrr</sup> R. Syarif, <sup>146</sup> E. Usai, <sup>146</sup> D. Yu, <sup>146</sup> R. Band, <sup>147</sup>  
 C. Brainerd, <sup>147</sup> R. Breedon, <sup>147</sup> M. Calderon De La Barca Sanchez, <sup>147</sup> M. Chertok, <sup>147</sup> J. Conway, <sup>147</sup> R. Conway, <sup>147</sup>  
 P. T. Cox, <sup>147</sup> R. Erbacher, <sup>147</sup> C. Flores, <sup>147</sup> G. Funk, <sup>147</sup> F. Jensen, <sup>147</sup> W. Ko, <sup>147</sup> O. Kukral, <sup>147</sup> R. Lander, <sup>147</sup> M. Mulhearn, <sup>147</sup>  
 D. Pellett, <sup>147</sup> J. Pilot, <sup>147</sup> M. Shi, <sup>147</sup> D. Stolp, <sup>147</sup> D. Taylor, <sup>147</sup> K. Tos, <sup>147</sup> M. Tripathi, <sup>147</sup> Z. Wang, <sup>147</sup> F. Zhang, <sup>147</sup>  
 M. Bachtis, <sup>148</sup> C. Bravo, <sup>148</sup> R. Cousins, <sup>148</sup> A. Dasgupta, <sup>148</sup> A. Florent, <sup>148</sup> J. Hauser, <sup>148</sup> M. Ignatenko, <sup>148</sup> N. Mccoll, <sup>148</sup>  
 S. Regnard, <sup>148</sup> D. Saltzberg, <sup>148</sup> C. Schnaible, <sup>148</sup> V. Valuev, <sup>148</sup> K. Burt, <sup>149</sup> R. Clare, <sup>149</sup> J. W. Gary, <sup>149</sup>  
 S. M. A. Ghiasi Shirazi, <sup>149</sup> G. Hanson, <sup>149</sup> G. Karapostoli, <sup>149</sup> E. Kennedy, <sup>149</sup> O. R. Long, <sup>149</sup> M. Olmedo Negrete, <sup>149</sup>  
 M. I. Paneva, <sup>149</sup> W. Si, <sup>149</sup> L. Wang, <sup>149</sup> H. Wei, <sup>149</sup> S. Wimpenny, <sup>149</sup> B. R. Yates, <sup>149</sup> Y. Zhang, <sup>149</sup> J. G. Branson, <sup>150</sup> P. Chang, <sup>150</sup>  
 S. Cittolin, <sup>150</sup> M. Derdzinski, <sup>150</sup> R. Gerosa, <sup>150</sup> D. Gilbert, <sup>150</sup> B. Hashemi, <sup>150</sup> D. Klein, <sup>150</sup> V. Krutelyov, <sup>150</sup> J. Letts, <sup>150</sup>  
 M. Masciovecchio, <sup>150</sup> S. May, <sup>150</sup> S. Padhi, <sup>150</sup> M. Pieri, <sup>150</sup> V. Sharma, <sup>150</sup> M. Tadel, <sup>150</sup> F. Würthwein, <sup>150</sup> A. Yagil, <sup>150</sup>  
 G. Zevi Della Porta, <sup>150</sup> N. Amin, <sup>151</sup> R. Bhandari, <sup>151</sup> C. Campagnari, <sup>151</sup> M. Citron, <sup>151</sup> V. Dutta, <sup>151</sup> M. Franco Sevilla, <sup>151</sup>  
 L. Gouskos, <sup>151</sup> J. Incandela, <sup>151</sup> B. Marsh, <sup>151</sup> H. Mei, <sup>151</sup> A. Ovcharova, <sup>151</sup> H. Qu, <sup>151</sup> J. Richman, <sup>151</sup> U. Sarica, <sup>151</sup> D. Stuart, <sup>151</sup>  
 S. Wang, <sup>151</sup> J. Yoo, <sup>151</sup> D. Anderson, <sup>152</sup> A. Bornheim, <sup>152</sup> J. M. Lawhorn, <sup>152</sup> N. Lu, <sup>152</sup> H. B. Newman, <sup>152</sup> T. Q. Nguyen, <sup>152</sup>  
 J. Pata, <sup>152</sup> M. Spiropulu, <sup>152</sup> J. R. Vlimant, <sup>152</sup> S. Xie, <sup>152</sup> Z. Zhang, <sup>152</sup> R. Y. Zhu, <sup>152</sup> M. B. Andrews, <sup>153</sup> T. Ferguson, <sup>153</sup>  
 T. Mudholkar, <sup>153</sup> M. Paulini, <sup>153</sup> M. Sun, <sup>153</sup> I. Vorobiev, <sup>153</sup> M. Weinberg, <sup>153</sup> J. P. Cumalat, <sup>154</sup> W. T. Ford, <sup>154</sup> A. Johnson, <sup>154</sup>  
 E. MacDonald, <sup>154</sup> T. Mulholland, <sup>154</sup> R. Patel, <sup>154</sup> A. Perloff, <sup>154</sup> K. Stenson, <sup>154</sup> K. A. Ulmer, <sup>154</sup> S. R. Wagner, <sup>154</sup>  
 J. Alexander, <sup>155</sup> J. Chaves, <sup>155</sup> Y. Cheng, <sup>155</sup> J. Chu, <sup>155</sup> A. Datta, <sup>155</sup> A. Frankenthal, <sup>155</sup> K. Mcdermott, <sup>155</sup> N. Mirman, <sup>155</sup>  
 J. R. Patterson, <sup>155</sup> D. Quach, <sup>155</sup> A. Rinkevicius, <sup>155,sss</sup> A. Ryd, <sup>155</sup> S. M. Tan, <sup>155</sup> Z. Tao, <sup>155</sup> J. Thom, <sup>155</sup> P. Wittich, <sup>155</sup>

M. Zientek,<sup>155</sup> S. Abdullin,<sup>156</sup> M. Albrow,<sup>156</sup> M. Alyari,<sup>156</sup> G. Apollinari,<sup>156</sup> A. Apresyan,<sup>156</sup> A. Apyan,<sup>156</sup> S. Banerjee,<sup>156</sup>  
L. A. T. Bauerdick,<sup>156</sup> A. Beretvas,<sup>156</sup> J. Berryhill,<sup>156</sup> P. C. Bhat,<sup>156</sup> K. Burkett,<sup>156</sup> J. N. Butler,<sup>156</sup> A. Canepa,<sup>156</sup>  
G. B. Cerati,<sup>156</sup> H. W. K. Cheung,<sup>156</sup> F. Chlebana,<sup>156</sup> M. Cremonesi,<sup>156</sup> J. Duarte,<sup>156</sup> V. D. Elvira,<sup>156</sup> J. Freeman,<sup>156</sup>  
Z. Gecse,<sup>156</sup> E. Gottschalk,<sup>156</sup> L. Gray,<sup>156</sup> D. Green,<sup>156</sup> S. Grünendahl,<sup>156</sup> O. Gutsche,<sup>156</sup> Allison Reinsvold Hall,<sup>156</sup>  
J. Hanlon,<sup>156</sup> R. M. Harris,<sup>156</sup> S. Hasegawa,<sup>156</sup> R. Heller,<sup>156</sup> J. Hirschauer,<sup>156</sup> B. Jayatilaka,<sup>156</sup> S. Jindariani,<sup>156</sup>  
M. Johnson,<sup>156</sup> U. Joshi,<sup>156</sup> B. Klima,<sup>156</sup> M. J. Kortelainen,<sup>156</sup> B. Kreis,<sup>156</sup> S. Lammel,<sup>156</sup> J. Lewis,<sup>156</sup> D. Lincoln,<sup>156</sup>  
R. Lipton,<sup>156</sup> M. Liu,<sup>156</sup> T. Liu,<sup>156</sup> J. Lykken,<sup>156</sup> K. Maeshima,<sup>156</sup> J. M. Marraffino,<sup>156</sup> D. Mason,<sup>156</sup> P. McBride,<sup>156</sup>  
P. Merkel,<sup>156</sup> S. Mrenna,<sup>156</sup> S. Nahn,<sup>156</sup> V. O'Dell,<sup>156</sup> V. Papadimitriou,<sup>156</sup> K. Pedro,<sup>156</sup> C. Pena,<sup>156</sup> G. Rakness,<sup>156</sup>  
F. Ravera,<sup>156</sup> L. Ristori,<sup>156</sup> B. Schneider,<sup>156</sup> E. Sexton-Kennedy,<sup>156</sup> N. Smith,<sup>156</sup> A. Soha,<sup>156</sup> W. J. Spalding,<sup>156</sup> L. Spiegel,<sup>156</sup>  
S. Stoynev,<sup>156</sup> J. Strait,<sup>156</sup> N. Strobbe,<sup>156</sup> L. Taylor,<sup>156</sup> S. Tkaczyk,<sup>156</sup> N. V. Tran,<sup>156</sup> L. Uplegger,<sup>156</sup> E. W. Vaandering,<sup>156</sup>  
C. Vernieri,<sup>156</sup> M. Verzocchi,<sup>156</sup> R. Vidal,<sup>156</sup> M. Wang,<sup>156</sup> H. A. Weber,<sup>156</sup> D. Acosta,<sup>157</sup> P. Avery,<sup>157</sup> P. Bortignon,<sup>157</sup>  
D. Bourilkov,<sup>157</sup> A. Brinkerhoff,<sup>157</sup> L. Cadamuro,<sup>157</sup> A. Carnes,<sup>157</sup> V. Cherepanov,<sup>157</sup> D. Curry,<sup>157</sup> F. Errico,<sup>157</sup> R. D. Field,<sup>157</sup>  
S. V. Gleyzer,<sup>157</sup> B. M. Joshi,<sup>157</sup> M. Kim,<sup>157</sup> J. Konigsberg,<sup>157</sup> A. Korytov,<sup>157</sup> K. H. Lo,<sup>157</sup> P. Ma,<sup>157</sup> K. Matchev,<sup>157</sup>  
N. Menendez,<sup>157</sup> G. Mitselmakher,<sup>157</sup> D. Rosenzweig,<sup>157</sup> K. Shi,<sup>157</sup> J. Wang,<sup>157</sup> S. Wang,<sup>157</sup> X. Zuo,<sup>157</sup> Y. R. Joshi,<sup>158</sup>  
T. Adams,<sup>159</sup> A. Askew,<sup>159</sup> S. Hagopian,<sup>159</sup> V. Hagopian,<sup>159</sup> K. F. Johnson,<sup>159</sup> R. Khurana,<sup>159</sup> T. Kolberg,<sup>159</sup> G. Martinez,<sup>159</sup>  
T. Perry,<sup>159</sup> H. Prosper,<sup>159</sup> C. Schiber,<sup>159</sup> R. Yohay,<sup>159</sup> J. Zhang,<sup>159</sup> M. M. Baarmand,<sup>160</sup> V. Bhopatkar,<sup>160</sup> M. Hohlmann,<sup>160</sup>  
D. Noonan,<sup>160</sup> M. Rahmani,<sup>160</sup> M. Saunders,<sup>160</sup> F. Yumiceva,<sup>160</sup> M. R. Adams,<sup>161</sup> L. Apanasevich,<sup>161</sup> D. Berry,<sup>161</sup>  
R. R. Betts,<sup>161</sup> R. Cavanaugh,<sup>161</sup> X. Chen,<sup>161</sup> S. Dittmer,<sup>161</sup> O. Evdokimov,<sup>161</sup> C. E. Gerber,<sup>161</sup> D. A. Hangal,<sup>161</sup>  
D. J. Hofman,<sup>161</sup> K. Jung,<sup>161</sup> C. Mills,<sup>161</sup> T. Roy,<sup>161</sup> M. B. Tonjes,<sup>161</sup> N. Varelas,<sup>161</sup> H. Wang,<sup>161</sup> X. Wang,<sup>161</sup> Z. Wu,<sup>161</sup>  
M. Alhusseini,<sup>162</sup> B. Bilki,<sup>162,bbb</sup> W. Clarida,<sup>162</sup> K. Dilsiz,<sup>162,ttt</sup> S. Durgut,<sup>162</sup> R. P. Gandrajula,<sup>162</sup> M. Haytmyradov,<sup>162</sup>  
V. Khristenko,<sup>162</sup> O. K. Köseyan,<sup>162</sup> J.-P. Merlo,<sup>162</sup> A. Mestvirishvili,<sup>162,uuu</sup> A. Moeller,<sup>162</sup> J. Nachtman,<sup>162</sup> H. Ogul,<sup>162,vvv</sup>  
Y. Onel,<sup>162</sup> F. Ozok,<sup>162,www</sup> A. Penzo,<sup>162</sup> C. Snyder,<sup>162</sup> E. Tiras,<sup>162</sup> J. Wetzel,<sup>162</sup> B. Blumenfeld,<sup>163</sup> A. Cocoros,<sup>163</sup>  
N. Eminizer,<sup>163</sup> D. Fehling,<sup>163</sup> L. Feng,<sup>163</sup> A. V. Gritsan,<sup>163</sup> W. T. Hung,<sup>163</sup> P. Maksimovic,<sup>163</sup> J. Roskes,<sup>163</sup> M. Swartz,<sup>163</sup>  
M. Xiao,<sup>163</sup> C. Baldenegro Barrera,<sup>164</sup> P. Baringer,<sup>164</sup> A. Bean,<sup>164</sup> S. Boren,<sup>164</sup> J. Bowen,<sup>164</sup> A. Bylinkin,<sup>164</sup> T. Isidori,<sup>164</sup>  
S. Khalil,<sup>164</sup> J. King,<sup>164</sup> G. Krintiras,<sup>164</sup> A. Kropivnitskaya,<sup>164</sup> C. Lindsey,<sup>164</sup> D. Majumder,<sup>164</sup> W. Mcbrayer,<sup>164</sup>  
N. Minafra,<sup>164</sup> M. Murray,<sup>164</sup> C. Rogan,<sup>164</sup> C. Royon,<sup>164</sup> S. Sanders,<sup>164</sup> E. Schmitz,<sup>164</sup> J. D. Tapia Takaki,<sup>164</sup> Q. Wang,<sup>164</sup>  
J. Williams,<sup>164</sup> S. Duric,<sup>165</sup> A. Ivanov,<sup>165</sup> K. Kaadze,<sup>165</sup> D. Kim,<sup>165</sup> Y. Maravin,<sup>165</sup> D. R. Mendis,<sup>165</sup> T. Mitchell,<sup>165</sup>  
A. Modak,<sup>165</sup> A. Mohammadi,<sup>165</sup> F. Rebassoo,<sup>166</sup> D. Wright,<sup>166</sup> A. Baden,<sup>167</sup> O. Baron,<sup>167</sup> A. Belloni,<sup>167</sup> S. C. Eno,<sup>167</sup>  
Y. Feng,<sup>167</sup> N. J. Hadley,<sup>167</sup> S. Jabeen,<sup>167</sup> G. Y. Jeng,<sup>167</sup> R. G. Kellogg,<sup>167</sup> J. Kunkle,<sup>167</sup> A. C. Mignerey,<sup>167</sup> S. Nabili,<sup>167</sup>  
F. Ricci-Tam,<sup>167</sup> M. Seidel,<sup>167</sup> Y. H. Shin,<sup>167</sup> A. Skuja,<sup>167</sup> S. C. Tonwar,<sup>167</sup> K. Wong,<sup>167</sup> D. Abercrombie,<sup>168</sup> B. Allen,<sup>168</sup>  
A. Baty,<sup>168</sup> R. Bi,<sup>168</sup> S. Brandt,<sup>168</sup> W. Busza,<sup>168</sup> I. A. Cali,<sup>168</sup> M. D'Alfonso,<sup>168</sup> G. Gomez Ceballos,<sup>168</sup> M. Goncharov,<sup>168</sup>  
P. Harris,<sup>168</sup> D. Hsu,<sup>168</sup> M. Hu,<sup>168</sup> M. Klute,<sup>168</sup> D. Kovalskyi,<sup>168</sup> Y.-J. Lee,<sup>168</sup> P. D. Luckey,<sup>168</sup> B. Maier,<sup>168</sup> A. C. Marini,<sup>168</sup>  
C. McGinn,<sup>168</sup> C. Mironov,<sup>168</sup> S. Narayanan,<sup>168</sup> X. Niu,<sup>168</sup> C. Paus,<sup>168</sup> D. Rankin,<sup>168</sup> C. Roland,<sup>168</sup> G. Roland,<sup>168</sup> Z. Shi,<sup>168</sup>  
G. S. F. Stephens,<sup>168</sup> K. Sumorok,<sup>168</sup> K. Tatar,<sup>168</sup> D. Velicanu,<sup>168</sup> J. Wang,<sup>168</sup> T. W. Wang,<sup>168</sup> B. Wyslouch,<sup>168</sup>  
A. C. Benvenuti,<sup>169,a</sup> R. M. Chatterjee,<sup>169</sup> A. Evans,<sup>169</sup> S. Guts,<sup>169</sup> P. Hansen,<sup>169</sup> J. Hiltbrand,<sup>169</sup> S. Kalafut,<sup>169</sup> Y. Kubota,<sup>169</sup>  
Z. Lesko,<sup>169</sup> J. Mans,<sup>169</sup> R. Rusack,<sup>169</sup> M. A. Wadud,<sup>169</sup> J. G. Acosta,<sup>170</sup> S. Oliveros,<sup>170</sup> K. Bloom,<sup>171</sup> D. R. Claes,<sup>171</sup>  
C. Fangmeier,<sup>171</sup> L. Finco,<sup>171</sup> F. Golf,<sup>171</sup> R. Gonzalez Suarez,<sup>171</sup> R. Kamalieddin,<sup>171</sup> I. Kravchenko,<sup>171</sup> J. E. Siado,<sup>171</sup>  
G. R. Snow,<sup>171</sup> B. Stieger,<sup>171</sup> C. Harrington,<sup>172</sup> I. Iashvili,<sup>172</sup> A. Kharchilava,<sup>172</sup> C. Mclean,<sup>172</sup> D. Nguyen,<sup>172</sup> A. Parker,<sup>172</sup>  
J. Pekkanen,<sup>172</sup> S. Rappoccio,<sup>172</sup> B. Roozbahani,<sup>172</sup> G. Alverson,<sup>173</sup> E. Barberis,<sup>173</sup> C. Freer,<sup>173</sup> Y. Haddad,<sup>173</sup>  
A. Hortiangtham,<sup>173</sup> G. Madigan,<sup>173</sup> D. M. Morse,<sup>173</sup> T. Orimoto,<sup>173</sup> L. Skinnari,<sup>173</sup> A. Tishelman-Charny,<sup>173</sup>  
T. Wamorkar,<sup>173</sup> B. Wang,<sup>173</sup> A. Wisecarver,<sup>173</sup> D. Wood,<sup>173</sup> S. Bhattacharya,<sup>174</sup> J. Bueghly,<sup>174</sup> T. Gunter,<sup>174</sup> K. A. Hahn,<sup>174</sup>  
N. Odell,<sup>174</sup> M. H. Schmitt,<sup>174</sup> K. Sung,<sup>174</sup> M. Trovato,<sup>174</sup> M. Velasco,<sup>174</sup> R. Bucci,<sup>175</sup> N. Dev,<sup>175</sup> R. Goldouzian,<sup>175</sup>  
M. Hildreth,<sup>175</sup> K. Hurtado Anampa,<sup>175</sup> C. Jessop,<sup>175</sup> D. J. Karmgard,<sup>175</sup> K. Lannon,<sup>175</sup> W. Li,<sup>175</sup> N. Loukas,<sup>175</sup>  
N. Marinelli,<sup>175</sup> I. Mcalister,<sup>175</sup> F. Meng,<sup>175</sup> C. Mueller,<sup>175</sup> Y. Musienko,<sup>175,ll</sup> M. Planer,<sup>175</sup> R. Ruchti,<sup>175</sup> P. Siddireddy,<sup>175</sup>  
G. Smith,<sup>175</sup> S. Taroni,<sup>175</sup> M. Wayne,<sup>175</sup> A. Wightman,<sup>175</sup> M. Wolf,<sup>175</sup> A. Woodard,<sup>175</sup> J. Alimena,<sup>176</sup> B. Bylsma,<sup>176</sup>  
L. S. Durkin,<sup>176</sup> S. Flowers,<sup>176</sup> B. Francis,<sup>176</sup> C. Hill,<sup>176</sup> W. Ji,<sup>176</sup> A. Lefeld,<sup>176</sup> T. Y. Ling,<sup>176</sup> B. L. Winer,<sup>176</sup>  
S. Cooperstein,<sup>177</sup> G. Dezoort,<sup>177</sup> P. Elmer,<sup>177</sup> J. Hardenbrook,<sup>177</sup> N. Haubrich,<sup>177</sup> S. Higginbotham,<sup>177</sup>  
A. Kalogeropoulos,<sup>177</sup> S. Kwan,<sup>177</sup> D. Lange,<sup>177</sup> M. T. Lucchini,<sup>177</sup> J. Luo,<sup>177</sup> D. Marlow,<sup>177</sup> K. Mei,<sup>177</sup> I. Ojalvo,<sup>177</sup>  
J. Olsen,<sup>177</sup> C. Palmer,<sup>177</sup> P. Piroué,<sup>177</sup> J. Salfeld-Nebgen,<sup>177</sup> D. Stickland,<sup>177</sup> C. Tully,<sup>177</sup> Z. Wang,<sup>177</sup> S. Malik,<sup>178</sup>

S. Norberg,<sup>178</sup> A. Barker,<sup>179</sup> V. E. Barnes,<sup>179</sup> S. Das,<sup>179</sup> L. Gutay,<sup>179</sup> M. Jones,<sup>179</sup> A. W. Jung,<sup>179</sup> A. Khatiwada,<sup>179</sup> B. Mahakud,<sup>179</sup> D. H. Miller,<sup>179</sup> G. Negro,<sup>179</sup> N. Neumeister,<sup>179</sup> C. C. Peng,<sup>179</sup> S. Piperov,<sup>179</sup> H. Qiu,<sup>179</sup> J. F. Schulte,<sup>179</sup> J. Sun,<sup>179</sup> F. Wang,<sup>179</sup> R. Xiao,<sup>179</sup> W. Xie,<sup>179</sup> T. Cheng,<sup>180</sup> J. Dolen,<sup>180</sup> N. Parashar,<sup>180</sup> K. M. Ecklund,<sup>181</sup> S. Freed,<sup>181</sup> F. J. M. Geurts,<sup>181</sup> M. Kilpatrick,<sup>181</sup> Arun Kumar,<sup>181</sup> W. Li,<sup>181</sup> B. P. Padley,<sup>181</sup> R. Redjimi,<sup>181</sup> J. Roberts,<sup>181</sup> J. Rorie,<sup>181</sup> W. Shi,<sup>181</sup> A. G. Stahl Leiton,<sup>181</sup> Z. Tu,<sup>181</sup> A. Zhang,<sup>181</sup> A. Bodek,<sup>182</sup> P. de Barbaro,<sup>182</sup> R. Demina,<sup>182</sup> J. L. Dulemba,<sup>182</sup> C. Fallon,<sup>182</sup> T. Ferbel,<sup>182</sup> M. Galanti,<sup>182</sup> A. Garcia-Bellido,<sup>182</sup> J. Han,<sup>182</sup> O. Hindrichs,<sup>182</sup> A. Khukhunaishvili,<sup>182</sup> E. Ranken,<sup>182</sup> P. Tan,<sup>182</sup> R. Taus,<sup>182</sup> B. Chiarito,<sup>183</sup> J. P. Chou,<sup>183</sup> A. Gandrakota,<sup>183</sup> Y. Gershtein,<sup>183</sup> E. Halkiadakis,<sup>183</sup> A. Hart,<sup>183</sup> M. Heindl,<sup>183</sup> E. Hughes,<sup>183</sup> S. Kaplan,<sup>183</sup> S. Kyriacou,<sup>183</sup> I. Laflotte,<sup>183</sup> A. Lath,<sup>183</sup> R. Montalvo,<sup>183</sup> K. Nash,<sup>183</sup> M. Osherson,<sup>183</sup> H. Saka,<sup>183</sup> S. Salur,<sup>183</sup> S. Schnetzer,<sup>183</sup> D. Sheffield,<sup>183</sup> S. Somalwar,<sup>183</sup> R. Stone,<sup>183</sup> S. Thomas,<sup>183</sup> P. Thomassen,<sup>183</sup> H. Acharya,<sup>184</sup> A. G. Delannoy,<sup>184</sup> J. Heideman,<sup>184</sup> G. Riley,<sup>184</sup> S. Spanier,<sup>184</sup> O. Bouhali,<sup>185,xxx</sup> A. Celik,<sup>185</sup> M. Dalchenko,<sup>185</sup> M. De Mattia,<sup>185</sup> A. Delgado,<sup>185</sup> S. Dildick,<sup>185</sup> R. Eusebi,<sup>185</sup> J. Gilmore,<sup>185</sup> T. Huang,<sup>185</sup> T. Kamon,<sup>185,yyy</sup> S. Luo,<sup>185</sup> D. Marley,<sup>185</sup> R. Mueller,<sup>185</sup> D. Overton,<sup>185</sup> L. Perniè,<sup>185</sup> D. Rathjens,<sup>185</sup> A. Safonov,<sup>185</sup> N. Akchurin,<sup>186</sup> J. Damgov,<sup>186</sup> F. De Guio,<sup>186</sup> S. Kunori,<sup>186</sup> K. Lamichhane,<sup>186</sup> S. W. Lee,<sup>186</sup> T. Mengke,<sup>186</sup> S. Muthumuni,<sup>186</sup> T. Peltola,<sup>186</sup> S. Undleeb,<sup>186</sup> I. Volobouev,<sup>186</sup> Z. Wang,<sup>186</sup> A. Whitbeck,<sup>186</sup> S. Greene,<sup>187</sup> A. Gurrola,<sup>187</sup> R. Janjam,<sup>187</sup> W. Johns,<sup>187</sup> C. Maguire,<sup>187</sup> A. Melo,<sup>187</sup> H. Ni,<sup>187</sup> K. Padeken,<sup>187</sup> F. Romeo,<sup>187</sup> P. Sheldon,<sup>187</sup> S. Tuo,<sup>187</sup> J. Velkovska,<sup>187</sup> M. Verweij,<sup>187</sup> M. W. Arenton,<sup>188</sup> P. Barria,<sup>188</sup> B. Cox,<sup>188</sup> G. Cummings,<sup>188</sup> R. Hirosky,<sup>188</sup> M. Joyce,<sup>188</sup> A. Ledovskoy,<sup>188</sup> C. Neu,<sup>188</sup> B. Tannenwald,<sup>188</sup> Y. Wang,<sup>188</sup> E. Wolfe,<sup>188</sup> F. Xia,<sup>188</sup> R. Harr,<sup>189</sup> P. E. Karchin,<sup>189</sup> N. Poudyal,<sup>189</sup> J. Sturdy,<sup>189</sup> P. Thapa,<sup>189</sup> S. Zaleski,<sup>189</sup> J. Buchanan,<sup>190</sup> C. Caillol,<sup>190</sup> D. Carlsmith,<sup>190</sup> S. Dasu,<sup>190</sup> I. De Bruyn,<sup>190</sup> L. Dodd,<sup>190</sup> F. Fiori,<sup>190</sup> C. Galloni,<sup>190</sup> B. Gomer,<sup>190,zzz</sup> M. Herndon,<sup>190</sup> A. Hervé,<sup>190</sup> U. Hussain,<sup>190</sup> P. Klabbers,<sup>190</sup> A. Lanaro,<sup>190</sup> A. Loeliger,<sup>190</sup> K. Long,<sup>190</sup> R. Loveless,<sup>190</sup> J. Madhusudanan Sreekala,<sup>190</sup> T. Ruggles,<sup>190</sup> A. Savin,<sup>190</sup> V. Sharma,<sup>190</sup> W. H. Smith,<sup>190</sup> D. Teague,<sup>190</sup> S. Trembath-reichert,<sup>190</sup> and N. Woods<sup>190</sup>

(CMS Collaboration)

<sup>1</sup>*Yerevan Physics Institute, Yerevan, Armenia*

<sup>2</sup>*Institut für Hochenergiephysik, Wien, Austria*

<sup>3</sup>*Institute for Nuclear Problems, Minsk, Belarus*

<sup>4</sup>*Universiteit Antwerpen, Antwerpen, Belgium*

<sup>5</sup>*Vrije Universiteit Brussel, Brussel, Belgium*

<sup>6</sup>*Université Libre de Bruxelles, Bruxelles, Belgium*

<sup>7</sup>*Ghent University, Ghent, Belgium*

<sup>8</sup>*Université Catholique de Louvain, Louvain-la-Neuve, Belgium*

<sup>9</sup>*Centro Brasileiro de Pesquisas Físicas, Rio de Janeiro, Brazil*

<sup>10</sup>*Universidade do Estado do Rio de Janeiro, Rio de Janeiro, Brazil*

<sup>11a</sup>*Universidade Estadual Paulista, São Paulo, Brazil*

<sup>11b</sup>*Universidade Federal do ABC, São Paulo, Brazil*

<sup>12</sup>*Institute for Nuclear Research and Nuclear Energy, Bulgarian Academy of Sciences, Sofia, Bulgaria*

<sup>13</sup>*University of Sofia, Sofia, Bulgaria*

<sup>14</sup>*Beihang University, Beijing, China*

<sup>15</sup>*Institute of High Energy Physics, Beijing, China*

<sup>16</sup>*State Key Laboratory of Nuclear Physics and Technology, Peking University, Beijing, China*

<sup>17</sup>*Tsinghua University, Beijing, China*

<sup>18</sup>*Universidad de Los Andes, Bogota, Colombia*

<sup>19</sup>*Universidad de Antioquia, Medellin, Colombia*

<sup>20</sup>*University of Split, Faculty of Electrical Engineering, Mechanical Engineering and Naval Architecture, Split, Croatia*

<sup>21</sup>*University of Split, Faculty of Science, Split, Croatia*

<sup>22</sup>*Institute Rudjer Boskovic, Zagreb, Croatia*

<sup>23</sup>*University of Cyprus, Nicosia, Cyprus*

<sup>24</sup>*Charles University, Prague, Czech Republic*

<sup>25</sup>*Escuela Politecnica Nacional, Quito, Ecuador*

<sup>26</sup>*Universidad San Francisco de Quito, Quito, Ecuador*

<sup>27</sup>*Academy of Scientific Research and Technology of the Arab Republic of Egypt, Egyptian Network of High Energy Physics, Cairo, Egypt*

<sup>28</sup>*National Institute of Chemical Physics and Biophysics, Tallinn, Estonia*



- <sup>29</sup>*Department of Physics, University of Helsinki, Helsinki, Finland*  
<sup>30</sup>*Helsinki Institute of Physics, Helsinki, Finland*  
<sup>31</sup>*Lappeenranta University of Technology, Lappeenranta, Finland*  
<sup>32</sup>*IRFU, CEA, Université Paris-Saclay, Gif-sur-Yvette, France*  
<sup>33</sup>*Laboratoire Leprince-Ringuet, Ecole polytechnique, CNRS/IN2P3, Université Paris-Saclay, Palaiseau, France*  
<sup>34</sup>*Université de Strasbourg, CNRS, IPHC UMR 7178, Strasbourg, France*  
<sup>35</sup>*Centre de Calcul de l'Institut National de Physique Nucleaire et de Physique des Particules, CNRS/IN2P3, Villeurbanne, France*  
<sup>36</sup>*Université de Lyon, Université Claude Bernard Lyon 1, CNRS-IN2P3, Institut de Physique Nucléaire de Lyon, Villeurbanne, France*  
<sup>37</sup>*Georgian Technical University, Tbilisi, Georgia*  
<sup>38</sup>*Tbilisi State University, Tbilisi, Georgia*  
<sup>39</sup>*RWTH Aachen University, I. Physikalisches Institut, Aachen, Germany*  
<sup>40</sup>*RWTH Aachen University, III. Physikalisches Institut A, Aachen, Germany*  
<sup>41</sup>*RWTH Aachen University, III. Physikalisches Institut B, Aachen, Germany*  
<sup>42</sup>*Deutsches Elektronen-Synchrotron, Hamburg, Germany*  
<sup>43</sup>*University of Hamburg, Hamburg, Germany*  
<sup>44</sup>*Karlsruher Institut fuer Technologie, Karlsruhe, Germany*  
<sup>45</sup>*Institute of Nuclear and Particle Physics (INPP), NCSR Demokritos, Aghia Paraskevi, Greece*  
<sup>46</sup>*National and Kapodistrian University of Athens, Athens, Greece*  
<sup>47</sup>*National Technical University of Athens, Athens, Greece*  
<sup>48</sup>*University of Ioánnina, Ioánnina, Greece*  
<sup>49</sup>*MTA-ELTE Lendület CMS Particle and Nuclear Physics Group, Eötvös Loránd University, Budapest, Hungary*  
<sup>50</sup>*Wigner Research Centre for Physics, Budapest, Hungary*  
<sup>51</sup>*Institute of Nuclear Research ATOMKI, Debrecen, Hungary*  
<sup>52</sup>*Institute of Physics, University of Debrecen, Debrecen, Hungary*  
<sup>53</sup>*Eszterhazy Karoly University, Karoly Robert Campus, Gyongyos, Hungary*  
<sup>54</sup>*Indian Institute of Science (IISc), Bangalore, India*  
<sup>55</sup>*National Institute of Science Education and Research, HBNI, Bhubaneswar, India*  
<sup>56</sup>*Panjab University, Chandigarh, India*  
<sup>57</sup>*University of Delhi, Delhi, India*  
<sup>58</sup>*Saha Institute of Nuclear Physics, HBNI, Kolkata, India*  
<sup>59</sup>*Indian Institute of Technology Madras, Madras, India*  
<sup>60</sup>*Bhabha Atomic Research Centre, Mumbai, India*  
<sup>61</sup>*Tata Institute of Fundamental Research-A, Mumbai, India*  
<sup>62</sup>*Tata Institute of Fundamental Research-B, Mumbai, India*  
<sup>63</sup>*Indian Institute of Science Education and Research (IISER), Pune, India*  
<sup>64</sup>*Institute for Research in Fundamental Sciences (IPM), Tehran, Iran*  
<sup>65</sup>*University College Dublin, Dublin, Ireland*  
<sup>66a</sup>*INFN Sezione di Bari, Bari, Italy*  
<sup>66b</sup>*Università di Bari, Bari, Italy*  
<sup>66c</sup>*Politecnico di Bari, Bari, Italy*  
<sup>67a</sup>*INFN Sezione di Bologna, Bologna, Italy*  
<sup>67b</sup>*Università di Bologna, Bologna, Italy*  
<sup>68a</sup>*INFN Sezione di Catania, Catania, Italy*  
<sup>68b</sup>*Università di Catania, Catania, Italy*  
<sup>69a</sup>*INFN Sezione di Firenze, Firenze, Italy*  
<sup>69b</sup>*Università di Firenze, Firenze, Italy*  
<sup>70</sup>*INFN Laboratori Nazionali di Frascati, Frascati, Italy*  
<sup>71a</sup>*INFN Sezione di Genova, Genova, Italy*  
<sup>71b</sup>*Università di Genova, Genova, Italy*  
<sup>72a</sup>*INFN Sezione di Milano-Bicocca, Milano, Italy*  
<sup>72b</sup>*Università di Milano-Bicocca, Milano, Italy*  
<sup>73a</sup>*INFN Sezione di Napoli, Napoli, Italy*  
<sup>73b</sup>*Università di Napoli 'Federico II', Napoli, Italy*  
<sup>73c</sup>*Università della Basilicata, Potenza, Italy*  
<sup>73d</sup>*Università G. Marconi, Roma, Italy*  
<sup>74a</sup>*INFN Sezione di Padova, Padova, Italy*

- <sup>74b</sup>Università di Padova, Padova, Italy  
<sup>74c</sup>Università di Trento, Trento, Italy  
<sup>75a</sup>INFN Sezione di Pavia, Pavia, Italy  
<sup>75b</sup>Università di Pavia, Pavia, Italy  
<sup>76a</sup>INFN Sezione di Perugia, Perugia, Italy  
<sup>76b</sup>Università di Perugia, Perugia, Italy  
<sup>77a</sup>INFN Sezione di Pisa, Pisa, Italy  
<sup>77b</sup>Università di Pisa, Pisa, Italy  
<sup>77c</sup>Scuola Normale Superiore di Pisa, Pisa, Italy  
<sup>78a</sup>INFN Sezione di Roma, Rome, Italy  
<sup>78b</sup>Sapienza Università di Roma, Rome, Italy  
<sup>79a</sup>INFN Sezione di Torino, Torino, Italy  
<sup>79b</sup>Università di Torino, Torino, Italy  
<sup>79c</sup>Università del Piemonte Orientale, Novara, Italy  
<sup>80a</sup>INFN Sezione di Trieste, Trieste, Italy  
<sup>80b</sup>Università di Trieste, Trieste, Italy  
<sup>81</sup>Kyungpook National University, Daegu, Korea  
<sup>82</sup>Chonnam National University, Institute for Universe and Elementary Particles, Kwangju, Korea  
<sup>83</sup>Hanyang University, Seoul, Korea  
<sup>84</sup>Korea University, Seoul, Korea  
<sup>85</sup>Kyung Hee University, Department of Physics, Seoul, Korea  
<sup>86</sup>Sejong University, Seoul, Korea  
<sup>87</sup>Seoul National University, Seoul, Korea  
<sup>88</sup>University of Seoul, Seoul, Korea  
<sup>89</sup>Sungkyunkwan University, Suwon, Korea  
<sup>90</sup>Riga Technical University, Riga, Latvia  
<sup>91</sup>Vilnius University, Vilnius, Lithuania  
<sup>92</sup>National Centre for Particle Physics, Universiti Malaya, Kuala Lumpur, Malaysia  
<sup>93</sup>Universidad de Sonora (UNISON), Hermosillo, Mexico  
<sup>94</sup>Centro de Investigacion y de Estudios Avanzados del IPN, Mexico City, Mexico  
<sup>95</sup>Universidad Iberoamericana, Mexico City, Mexico  
<sup>96</sup>Benemerita Universidad Autonoma de Puebla, Puebla, Mexico  
<sup>97</sup>Universidad Autónoma de San Luis Potosí, San Luis Potosí, Mexico  
<sup>98</sup>University of Montenegro, Podgorica, Montenegro  
<sup>99</sup>University of Auckland, Auckland, New Zealand  
<sup>100</sup>University of Canterbury, Christchurch, New Zealand  
<sup>101</sup>National Centre for Physics, Quaid-I-Azam University, Islamabad, Pakistan  
<sup>102</sup>AGH University of Science and Technology Faculty of Computer Science, Electronics and Telecommunications, Krakow, Poland  
<sup>103</sup>National Centre for Nuclear Research, Swierk, Poland  
<sup>104</sup>Institute of Experimental Physics, Faculty of Physics, University of Warsaw, Warsaw, Poland  
<sup>105</sup>Laboratório de Instrumentação e Física Experimental de Partículas, Lisboa, Portugal  
<sup>106</sup>Joint Institute for Nuclear Research, Dubna, Russia  
<sup>107</sup>Petersburg Nuclear Physics Institute, Gatchina (St. Petersburg), Russia  
<sup>108</sup>Institute for Nuclear Research, Moscow, Russia  
<sup>109</sup>Institute for Theoretical and Experimental Physics named by A.I. Alikhanov of NRC 'Kurchatov Institute', Moscow, Russia  
<sup>110</sup>Moscow Institute of Physics and Technology, Moscow, Russia  
<sup>111</sup>National Research Nuclear University 'Moscow Engineering Physics Institute' (MEPhI), Moscow, Russia  
<sup>112</sup>P.N. Lebedev Physical Institute, Moscow, Russia  
<sup>113</sup>Skobeltsyn Institute of Nuclear Physics, Lomonosov Moscow State University, Moscow, Russia  
<sup>114</sup>Novosibirsk State University (NSU), Novosibirsk, Russia  
<sup>115</sup>Institute for High Energy Physics of National Research Centre 'Kurchatov Institute', Protvino, Russia  
<sup>116</sup>National Research Tomsk Polytechnic University, Tomsk, Russia  
<sup>117</sup>Tomsk State University, Tomsk, Russia  
<sup>118</sup>University of Belgrade: Faculty of Physics and VINCA Institute of Nuclear Sciences, Belgrade, Serbia  
<sup>119</sup>Centro de Investigaciones Energéticas Medioambientales y Tecnológicas (CIEMAT), Madrid, Spain  
<sup>120</sup>Universidad Autónoma de Madrid, Madrid, Spain

- <sup>121</sup>*Universidad de Oviedo, Instituto Universitario de Ciencias y Tecnologías Espaciales de Asturias (ICTEA), Oviedo, Spain*
- <sup>122</sup>*Instituto de Física de Cantabria (IFCA), CSIC-Universidad de Cantabria, Santander, Spain*
- <sup>123</sup>*University of Colombo, Colombo, Sri Lanka*
- <sup>124</sup>*University of Ruhuna, Department of Physics, Matara, Sri Lanka*
- <sup>125</sup>*CERN, European Organization for Nuclear Research, Geneva, Switzerland*
- <sup>126</sup>*Paul Scherrer Institut, Villigen, Switzerland*
- <sup>127</sup>*ETH Zurich - Institute for Particle Physics and Astrophysics (IPA), Zurich, Switzerland*
- <sup>128</sup>*Universität Zürich, Zurich, Switzerland*
- <sup>129</sup>*National Central University, Chung-Li, Taiwan*
- <sup>130</sup>*National Taiwan University (NTU), Taipei, Taiwan*
- <sup>131</sup>*Chulalongkorn University, Faculty of Science, Department of Physics, Bangkok, Thailand*
- <sup>132</sup>*Çukurova University, Physics Department, Science and Art Faculty, Adana, Turkey*
- <sup>133</sup>*Middle East Technical University, Physics Department, Ankara, Turkey*
- <sup>134</sup>*Bogazici University, Istanbul, Turkey*
- <sup>135</sup>*Istanbul Technical University, Istanbul, Turkey*
- <sup>136</sup>*Institute for Scintillation Materials of National Academy of Science of Ukraine, Kharkov, Ukraine*
- <sup>137</sup>*National Scientific Center, Kharkov Institute of Physics and Technology, Kharkov, Ukraine*
- <sup>138</sup>*University of Bristol, Bristol, United Kingdom*
- <sup>139</sup>*Rutherford Appleton Laboratory, Didcot, United Kingdom*
- <sup>140</sup>*Imperial College, London, United Kingdom*
- <sup>141</sup>*Brunel University, Uxbridge, United Kingdom*
- <sup>142</sup>*Baylor University, Waco, Texas, USA*
- <sup>143</sup>*Catholic University of America, Washington, DC, USA*
- <sup>144</sup>*The University of Alabama, Tuscaloosa, Alabama, USA*
- <sup>145</sup>*Boston University, Boston, Massachusetts, USA*
- <sup>146</sup>*Brown University, Providence, Rhode Island, USA*
- <sup>147</sup>*University of California, Davis, Davis, California, USA*
- <sup>148</sup>*University of California, Los Angeles, California, USA*
- <sup>149</sup>*University of California, Riverside, Riverside, California, USA*
- <sup>150</sup>*University of California, San Diego, La Jolla, California, USA*
- <sup>151</sup>*University of California, Santa Barbara - Department of Physics, Santa Barbara, California, USA*
- <sup>152</sup>*California Institute of Technology, Pasadena, California, USA*
- <sup>153</sup>*Carnegie Mellon University, Pittsburgh, Pennsylvania, USA*
- <sup>154</sup>*University of Colorado Boulder, Boulder, Colorado, USA*
- <sup>155</sup>*Cornell University, Ithaca, New York, USA*
- <sup>156</sup>*Fermi National Accelerator Laboratory, Batavia, Illinois, USA*
- <sup>157</sup>*University of Florida, Gainesville, Florida, USA*
- <sup>158</sup>*Florida International University, Miami, Florida, USA*
- <sup>159</sup>*Florida State University, Tallahassee, Florida, USA*
- <sup>160</sup>*Florida Institute of Technology, Melbourne, Florida, USA*
- <sup>161</sup>*University of Illinois at Chicago (UIC), Chicago, Illinois, USA*
- <sup>162</sup>*The University of Iowa, Iowa City, Iowa, USA*
- <sup>163</sup>*Johns Hopkins University, Baltimore, Maryland, USA*
- <sup>164</sup>*The University of Kansas, Lawrence, Kansas, USA*
- <sup>165</sup>*Kansas State University, Manhattan, Kansas, USA*
- <sup>166</sup>*Lawrence Livermore National Laboratory, Livermore, California, USA*
- <sup>167</sup>*University of Maryland, College Park, Maryland, USA*
- <sup>168</sup>*Massachusetts Institute of Technology, Cambridge, Massachusetts, USA*
- <sup>169</sup>*University of Minnesota, Minneapolis, Minnesota, USA*
- <sup>170</sup>*University of Mississippi, Oxford, Mississippi, USA*
- <sup>171</sup>*University of Nebraska-Lincoln, Lincoln, Nebraska, USA*
- <sup>172</sup>*State University of New York at Buffalo, Buffalo, New York, USA*
- <sup>173</sup>*Northeastern University, Boston, Massachusetts, USA*
- <sup>174</sup>*Northwestern University, Evanston, Illinois, USA*
- <sup>175</sup>*University of Notre Dame, Notre Dame, Indiana, USA*
- <sup>176</sup>*The Ohio State University, Columbus, Ohio, USA*
- <sup>177</sup>*Princeton University, Princeton, New Jersey, USA*
- <sup>178</sup>*University of Puerto Rico, Mayaguez, Puerto Rico, USA*
- <sup>179</sup>*Purdue University, West Lafayette, Indiana, USA*

- <sup>180</sup>*Purdue University Northwest, Hammond, Indiana, USA*  
<sup>181</sup>*Rice University, Houston, Texas, USA*  
<sup>182</sup>*University of Rochester, Rochester, New York, USA*  
<sup>183</sup>*Rutgers, The State University of New Jersey, Piscataway, New Jersey, USA*  
<sup>184</sup>*University of Tennessee, Knoxville, Tennessee, USA*  
<sup>185</sup>*Texas A&M University, College Station, Texas, USA*  
<sup>186</sup>*Texas Tech University, Lubbock, Texas, USA*  
<sup>187</sup>*Vanderbilt University, Nashville, Tennessee, USA*  
<sup>188</sup>*University of Virginia, Charlottesville, Virginia, USA*  
<sup>189</sup>*Wayne State University, Detroit, Michigan, USA*  
<sup>190</sup>*University of Wisconsin - Madison, Madison, Wisconsin, USA*

<sup>a</sup>Deceased.

<sup>b</sup>Also at Vienna University of Technology, Vienna, Austria.

<sup>c</sup>Also at IRFU, CEA, Université Paris-Saclay, Gif-sur-Yvette, France.

<sup>d</sup>Also at Universidade Estadual de Campinas, Campinas, Brazil.

<sup>e</sup>Also at Federal University of Rio Grande do Sul, Porto Alegre, Brazil.

<sup>f</sup>Also at Universidad Federal de Matto Grosso, Cuiaba, Brazil.

<sup>g</sup>Also at Universidade Federal de Pelotas, Pelotas, Brazil.

<sup>h</sup>Also at Université Libre de Bruxelles, Bruxelles, Belgium.

<sup>i</sup>Also at University of Chinese Academy of Sciences, Beijing, China.

<sup>j</sup>Also at Institute for Theoretical and Experimental Physics named by A.I. Alikhanov of NRC 'Kurchatov Institute', Moscow, Russia.

<sup>k</sup>Also at Joint Institute for Nuclear Research, Dubna, Russia.

<sup>l</sup>Also at Cairo University, Cairo, Egypt.

<sup>m</sup>Also at Helwan University, Cairo, Egypt.

<sup>n</sup>Also at Zewail City of Science and Technology, Zewail, Egypt.

<sup>o</sup>Also at Purdue University, West Lafayette, Indiana, USA.

<sup>p</sup>Also at Université de Haute Alsace, Mulhouse, France.

<sup>q</sup>Also at Tbilisi State University, Tbilisi, Georgia.

<sup>r</sup>Also at Erzincan Binali Yildirim University, Erzincan, Turkey.

<sup>s</sup>Also at CERN, European Organization for Nuclear Research, Geneva, Switzerland.

<sup>t</sup>Also at RWTH Aachen University, III. Physikalisches Institut A, Aachen, Germany.

<sup>u</sup>Also at University of Hamburg, Hamburg, Germany.

<sup>v</sup>Also at Brandenburg University of Technology, Cottbus, Germany.

<sup>w</sup>Also at Institute of Physics, University of Debrecen, Debrecen, Hungary.

<sup>x</sup>Also at Institute of Nuclear Research ATOMKI, Debrecen, Hungary.

<sup>y</sup>Also at MTA-ELTE Lendület CMS Particle and Nuclear Physics Group, Eötvös Loránd University, Budapest, Hungary.

<sup>z</sup>Also at IIT Bhubaneswar, Bhubaneswar, India.

<sup>aa</sup>Also at Institute of Physics, Bhubaneswar, India.

<sup>bb</sup>Also at Shoolini University, Solan, India.

<sup>cc</sup>Also at University of Visva-Bharati, Santiniketan, India.

<sup>dd</sup>Also at Isfahan University of Technology, Isfahan, Iran.

<sup>ee</sup>Also at Italian National Agency for New Technologies, Energy and Sustainable Economic Development, Rome, Italy.

<sup>ff</sup>Also at Centro Siciliano di Fisica Nucleare e di Struttura Della Materia.

<sup>gg</sup>Also at Scuola Normale e Sezione dell'INFN, Pisa, Italy.

<sup>hh</sup>Also at Riga Technical University, Riga, Latvia.

<sup>ii</sup>Also at Malaysian Nuclear Agency, MOSTI, Kajang, Malaysia.

<sup>jj</sup>Also at Consejo Nacional de Ciencia y Tecnología, Mexico City, Mexico.

<sup>kk</sup>Also at Warsaw University of Technology, Institute of Electronic Systems, Warsaw, Poland.

<sup>ll</sup>Also at Institute for Nuclear Research, Moscow, Russia.

<sup>mm</sup>Also at National Research Nuclear University 'Moscow Engineering Physics Institute' (MEPhI), Moscow, Russia.

<sup>nn</sup>Also at St. Petersburg State Polytechnical University, St. Petersburg, Russia.

<sup>oo</sup>Also at University of Florida, Gainesville, Florida, USA.

<sup>pp</sup>Also at Imperial College, London, United Kingdom.

<sup>qq</sup>Also at P.N. Lebedev Physical Institute, Moscow, Russia.

<sup>rr</sup>Also at California Institute of Technology, Pasadena, California, USA.

<sup>ss</sup>Also at Budker Institute of Nuclear Physics, Novosibirsk, Russia.

<sup>tt</sup>Also at Faculty of Physics, University of Belgrade, Belgrade, Serbia.

<sup>uu</sup>Also at Università degli Studi di Siena, Siena, Italy.

<sup>vv</sup>Also at INFN Sezione di Pavia, Università di Pavia, Pavia, Italy.



- <sup>ww</sup> Also at National and Kapodistrian University of Athens, Athens, Greece.
- <sup>xx</sup> Also at Universität Zürich, Zurich, Switzerland.
- <sup>yy</sup> Also at Stefan Meyer Institute for Subatomic Physics, Vienna, Austria.
- <sup>zz</sup> Also at Adiyaman University, Adiyaman, Turkey.
- <sup>aaa</sup> Also at Sirnak University, Sirnak, Turkey.
- <sup>bbb</sup> Also at Beykent University, Istanbul, Turkey.
- <sup>ccc</sup> Also at Istanbul Aydin University, Istanbul, Turkey.
- <sup>ddd</sup> Also at Mersin University, Mersin, Turkey.
- <sup>eee</sup> Also at Piri Reis University, Istanbul, Turkey.
- <sup>fff</sup> Also at Gaziosmanpasa University, Tokat, Turkey.
- <sup>ggg</sup> Also at Ozyegin University, Istanbul, Turkey.
- <sup>hhh</sup> Also at Izmir Institute of Technology, Izmir, Turkey.
- <sup>iii</sup> Also at Marmara University, Istanbul, Turkey.
- <sup>jjj</sup> Also at Kafkas University, Kars, Turkey.
- <sup>kkk</sup> Also at Istanbul University, Istanbul, Turkey.
- <sup>lll</sup> Also at Istanbul Bilgi University, Istanbul, Turkey.
- <sup>mmm</sup> Also at Hacettepe University, Ankara, Turkey.
- <sup>nnn</sup> Also at School of Physics and Astronomy, University of Southampton, Southampton, United Kingdom.
- <sup>ooo</sup> Also at IPPP Durham University, Durham, England.
- <sup>ppp</sup> Also at Monash University, Faculty of Science, Clayton, Australia.
- <sup>qqq</sup> Also at Bethel University, St. Paul, Minneapolis, USA.
- <sup>rrr</sup> Also at Karamanoğlu Mehmetbey University, Karaman, Turkey.
- <sup>sss</sup> Also at Vilnius University, Vilnius, Lithuania.
- <sup>ttt</sup> Also at Bingol University, Bingol, Turkey.
- <sup>uuu</sup> Also at Georgian Technical University, Tbilisi, Georgia.
- <sup>vvv</sup> Also at Sinop University, Sinop, Turkey.
- <sup>www</sup> Also at Mimar Sinan University, Istanbul, Istanbul, Turkey.
- <sup>xxx</sup> Also at Texas A&M University at Qatar, Doha, Qatar.
- <sup>yyy</sup> Also at Kyungpook National University, Daegu, Korea.
- <sup>zzz</sup> Also at University of Hyderabad, Hyderabad, India.